

# CNC DIAMOND TOOLS





# Contents

<b>About Us</b>	4
<b>Our Values</b>	6
Research & Development	
Customer Focus	
<b>Retailer Locations</b>	8
<b>North America Warehouse</b>	10
<b>Customer Service &amp; Technical Assistance</b>	12
<b>Our History</b>	14
<b>Certifications</b>	16
<b>Our Global Presence</b>	18
<b>Technologies</b>	
Frangistone	22
Razorstone	24
Hyper	26
Segmented	28
EHS	30
Zenith	32
Electroplated	34
BiPower	36
Glossforce3.0	38
Longlife+	40
<b>Technologies Overview</b>	42
<b>Advantages</b>	44
<b>Profiles Overview</b>	46
<b>CNC Tools</b>	
Finger-bits	50
Core Drills	54
Line 60	58
Line 40	100
Line 20	118
Line 10	142
Stubbing Wheels	152
Drainboard & Grooving Tools	156
Solid Sink Tools	160
Engraving Tools	164
Cones & Adapters	168



We proudly represent one of the leading Italian companies in the metal-mechanical sector, specializing in manufacturing diamond tools for processing natural and synthetic stone.

Internationally acclaimed, we boast the highest number of patents, utility models, and industrial designs in the stone industry, filed, extended, and confirmed on a global scale.

# About Us



# Our Values

## Research & Development

With four decades of experience, we have consistently regarded research and development as integral to our company's growth and the enhancement of our proposed technologies.

Each year, we invest approximately 7% of our revenue in research to continuously offer innovative and technologically advanced solutions to our esteemed clientele. Through our research efforts and collaboration with CNC machine manufacturers, we have successfully optimized the operational performance of our tools, resulting in highly innovative and unparalleled systems.

Furthermore, we firmly believe in safeguarding our intellectual property, and thus, each of our groundbreaking **inventions is protected by certified patents.**

## Customer Focus

We are dedicated to delivering prompt and professional pre-sales and after-sales services to our clients worldwide, offering **specialized technical assistance and expert consultations** tailored to their unique needs.

At the launch of every new product, we showcase demonstrations conducted by technicians who regularly utilize our machines, either in our facility or at international trade events.

Moreover, we conduct **training activities** during the installation and testing of purchased machines, employing a team of qualified technicians to ensure optimal usage of our diamond products.





**Purchase from your trusted retailer and receive directly from our centralized warehouse in North America**

Find your trusted distributor in this link



<https://marmoelettro.com/northamericalocations/>

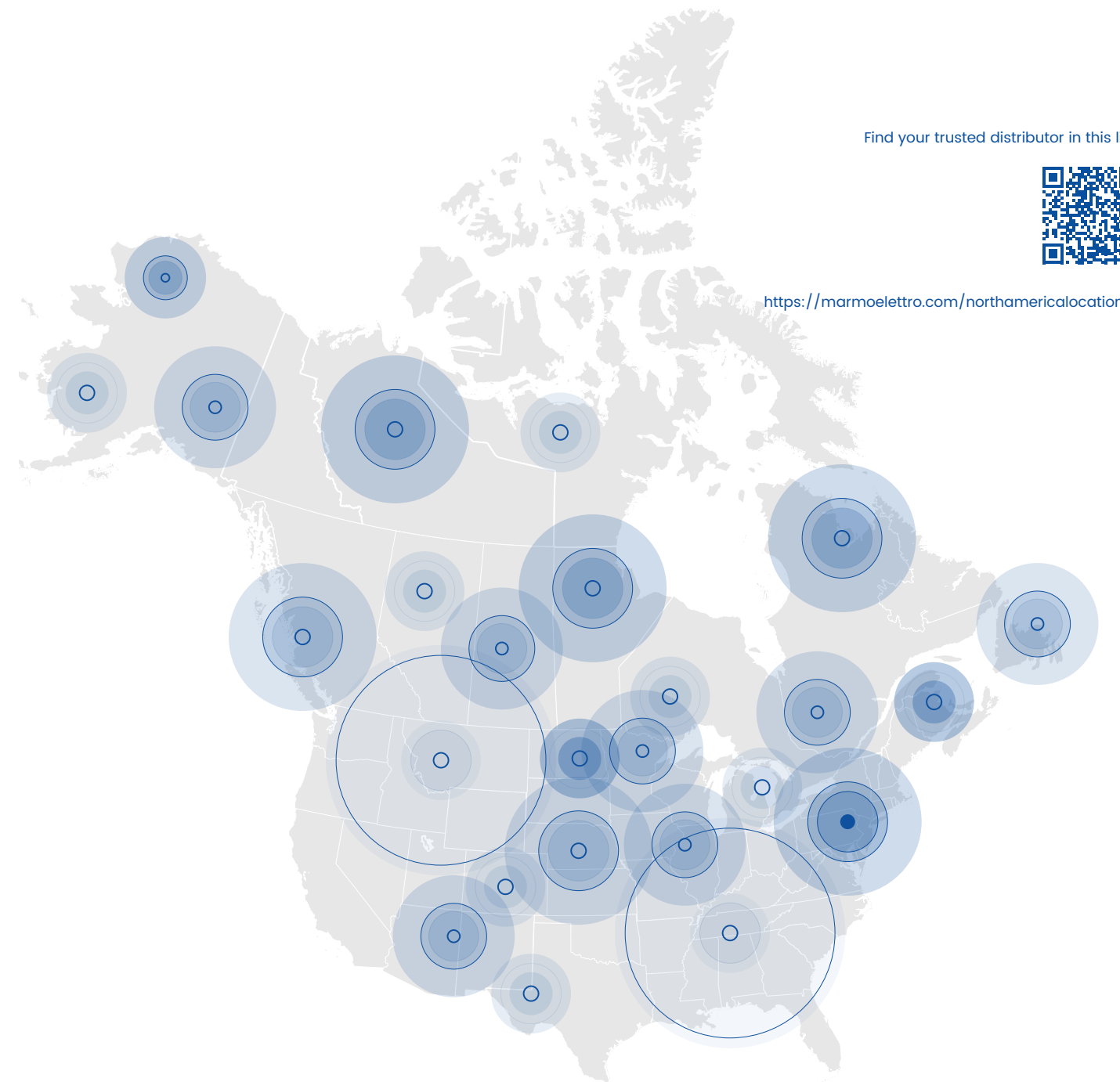

**Retailer Locations**



# Large inventory of CNC Tools



## North America Warehouse

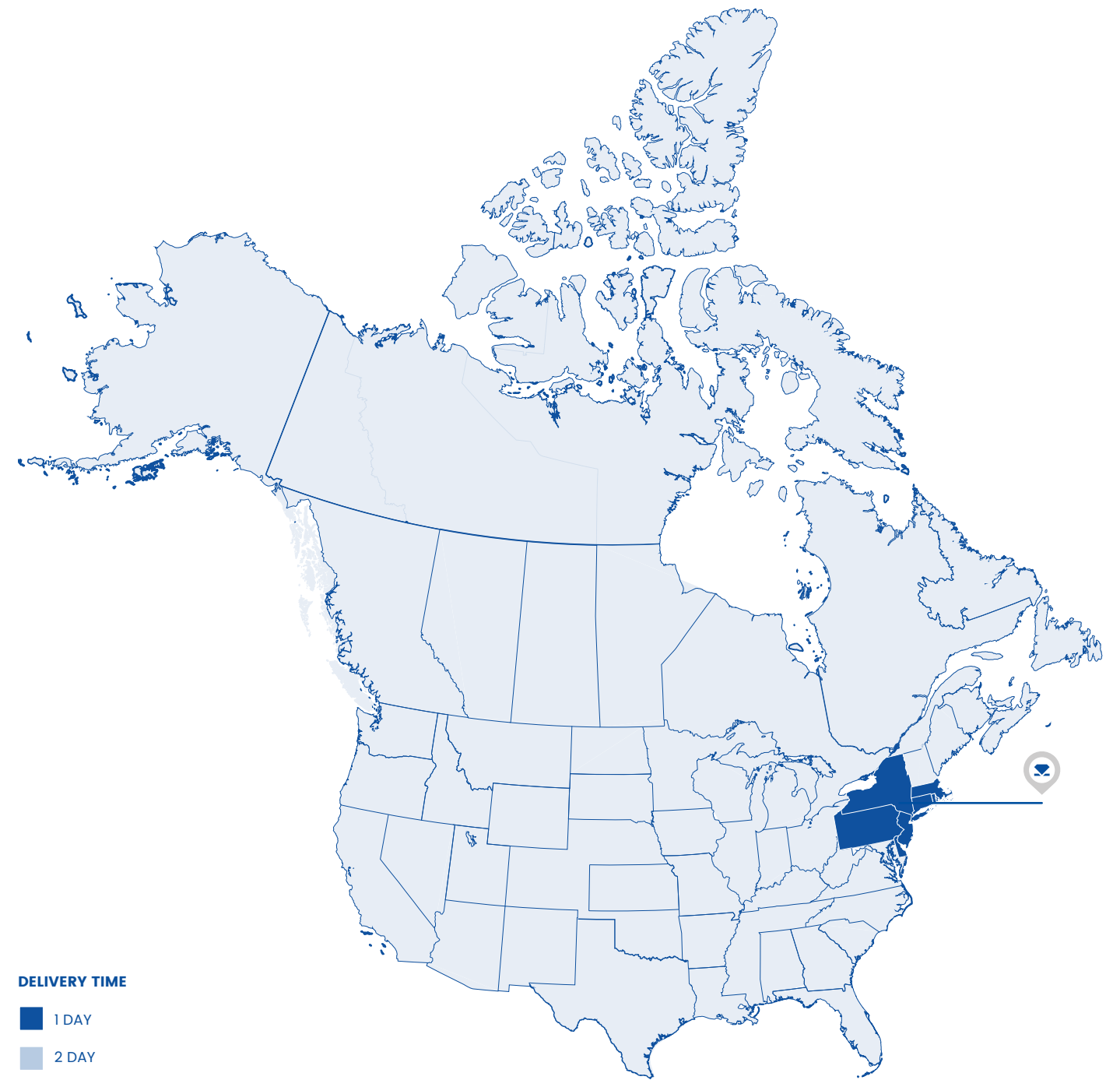



### **Online Support**

Experience superior online support for diamond tools in CNC machines. Our experts provide real-time assistance, tailored recommendations, and innovative solutions for precision machining, ensuring optimal performance and productivity in every operation.

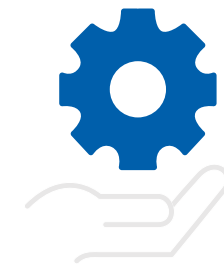

### **Onsite Support**

Elevate your CNC machining with our onsite support for diamond tools. Our experts bring tailored recommendations, real-time assistance, and innovative solutions to your location, ensuring optimal precision and productivity in every operation.

# **Customer Service & Technical Assistance**



Established in 1980 with the vision of simplifying and enhancing the processing of marble, granite, and natural stones, we have achieved our initial goals over the course of four decades and continue to strive for improvement through unwavering dedication.

Testimonials from thousands of operators worldwide stand as a testament to the validity, quality, and versatility of our products, all meticulously manufactured in strict compliance with international safety standards.

1989



**Rotating Toucher**

The simple but effective innovation which helped fabricators with guiding the router.

1990

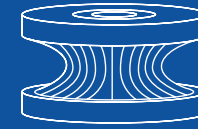

**Diamanflex**

The first polishing wheels introduced using abrasive tapes.

1992

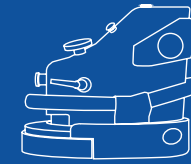

**Master Router**

The first router with a water gliding system which eased the motion of the machines.

1995

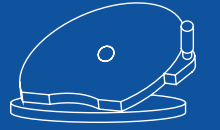

**Master Lift Support**

After this innovation the routers were not only for external edges.

1997



**Water System Fixed**

The smoothest motion of the industry

1999

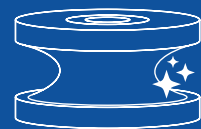

**Longlife Polishers**

The first diamond resin bonded polishing wheels introduced in the industry.

2000



**Frangistone**

Initial stock removal for profiles made simple.

2013

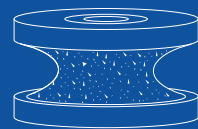

**EHS**

Our symbol of and the fastest metal tools in the industry.

2015



**Razorstone**

Helped fabricators to precut profiles faster than ever.



**Tripower & Pad3D**

5 Simple steps to achieve full polish.

2019

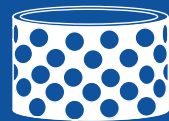

**Hyper - Z**

The best performing super-z tool

2023



**Longlife+**

The first rubber polishers upgraded to the best.

2024



**Glossforce 3.0**

The new generation of polishers which give a perfect homogenous finish.

2024



**Master 5000**

Revolutionized manual router

# Our History





# Certifications

Operating in adherence to rigorous standards, we have earned the prestigious **Quality Management System certification - UNI EN ISO 9001**. This commitment to excellence extends to health, safety, and environmental protection.

We firmly believe that our commitment to quality is the cornerstone of growth and competitiveness, and to that end, we invest in cultivating a highly qualified staff capable of independently managing all phases of production.





**Europe**

- Italy
- Austria
- Belgium
- Bulgaria
- Cyprus
- Croatia
- Denmark
- Estonia
- Finland
- France
- Germany
- Greece
- Ireland
- Latvia
- Lithuania
- Holland
- Poland
- Portugal
- Czech Republic
- Romania
- San Marino
- Serbia
- Slovakia
- Slovenia
- Spain
- Sweden
- Hungary
- Albania
- Bosnia
- Iceland
- Kosovo
- Moldova
- Norway
- United Kingdom
- Russia
- Swiss
- Türkiye
- Ukraine

**Oceania**

- Australia
- New Caledonia
- New Zeland
- Tahiti
- Vanuatu

**South America**

- Argentina
- Brazil
- French Guiana

**Asia**

- China
- UAE
- Philippines
- India
- Iran
- Israel
- Kuwait
- Sri Lanka
- Vietnam

**Africa**

- Egypt
- Morocco
- Nigeria
- South Africa
- Tunisia

**North America**

- Canada
- Guadeloupe
- Guatemala
- Mexico
- USA

# Our Global Presence

Our extensive organizational structure spans across the globe, while our Italian roots remain integral to our identity. Through a team of specialized personnel and state-of-the-art computer systems, we connect with clients worldwide, providing exceptional service and support.

Thanks to the exceptional quality of our products and our flexible organization, we have rapidly captured markets worldwide, garnering enthusiasm and unequivocal approval from users everywhere.

We ensure the swift and efficient delivery of our products across the world through an extensive network of distributors, retailers, and franchises.

Every day, our sales representatives, technicians, and agents offer tailored solutions to meet the diverse needs of our clients, all made possible through our extensive **catalog featuring over 4.000 products.**



Welcome to the cutting-edge world of our diamond tooling catalog, where technology reigns supreme in the natural and synthetic stone industry.

As a pioneer in the field, our company is renowned for its patented and unparalleled innovations, consistently leading the way with groundbreaking advancements. Our array of cutting-edge technologies holds paramount importance as they directly influence the production outcomes for our valued fabricators, ensuring that our clients achieve nothing short of excellence in their craftsmanship and material processing.

Unleash the power of innovation with our cutting-edge diamond tooling solutions, where every tool promises to be a catalyst for transformative success in your stone fabrication endeavors.

# Technologies





# Frangistone

Step into the revolutionary world of Frangistone – a true game-changer in the stone industry! Crafted with multiple discs featuring small spaces in between, these awe-inspiring breakers are the ultimate epitome of efficiency and precision. Say farewell to wasted energy and time-consuming profiling struggles, as Frangistone effortlessly removes excess material with finesse. It proudly stands tall as the first-ever multidisc tooling innovation, setting the golden standard that others could only dream of imitating. Prepare to be amazed as Frangistone leads the pack, leaving competitors trailing in its trailblazing wake. Embrace the legend, embrace the future – Frangistone, where excellence meets innovation!

The space between the blades increases the tool efficiency.



### Performance



### Suitable for:

- Granite
- Ceramic and Quartz

### Position:

**00** - Breaker

### Available for:







# Razorstone

An innovative multidisc technology that shatters boundaries! Without any gaps between its blades, this precut marvel redefines precision, delivering an impeccable, finer finish that leaves spectators in awe. Embrace the future of stone fabrication as Razorstone elevates not only the quality of your work but also extends the longevity of your main set, making it a smart investment for excellence. Step into a realm where innovation seamlessly blends with craftsmanship, and experience the unparalleled efficiency that Razorstone offers – the tool that sets a new standard, giving your projects the leading edge they deserve.

## Performance



## Suitable for:

- ▲ Granite
- Ceramic and Quartz

## Position:

- 0 - Pre-cutting

## Available for:



Without any gaps between its blades, this precut marvel redefines precision.

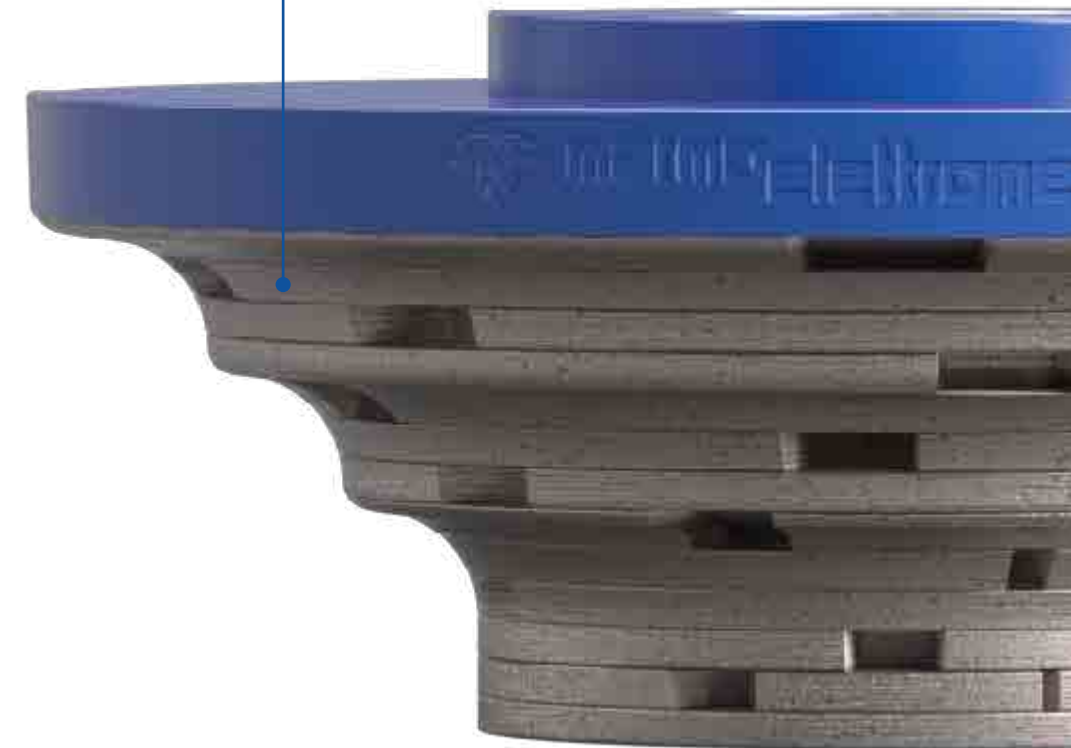



The specially designed holes help the lubrication and stock removal process.



# Hyper

“Hyper” – a revolutionary technology renowned for its unrivaled diamond bonds in the industry. Originally introduced through the remarkable Hyper-Z wheels, this innovation has redefined performance standards. Behold the sheer strength of these diamond bonds as Hyper tools outshine competitors, boasting an impressive six-fold increase in lifespan while performing tasks at a jaw-dropping five times the speed. Embrace the power of endurance and efficiency as “Hyper” propels your stone fabrication endeavors to unparalleled heights. Become part of the elite league of industry leaders, harnessing the true potential of “Hyper” technology for unmatched results.

### Performance



### Suitable for:

- Granite
- Ceramic and Quartz

### Position:

**Cleaner** - Pre-cutting

### Available for:





# Segmented

Segmented technology, a prevailing innovation in the stone fabrication industry, stands as a cornerstone of sintered advancements. It involves meticulously bonding diamond segments across a wheel's periphery, each segment encasing abrasive diamond grits. Renowned for its exceptional precision, durability, and versatility, segmented sintered wheels excel in cutting and shaping hard materials like granite, engineered stone, and concrete. These precisely positioned segments not only ensure efficient material removal but also diminish heat buildup, resulting in cleaner cuts and prolonged tool life. In a world where precision meets performance, segmented technology remains a driving force, delivering impeccable results across demanding applications.

These precisely positioned segments not only ensure efficient material removal but also diminish heat buildup.



## Performance



## Suitable for:

- ▲ Granite
- Ceramic and Quartz

## Position:

- - Pre-cutting

## Available for:

- Line 10
- Finger-bits
- Corebits
- Stubbing wheels



The only copper bonded metal profiling wheels in the world.



# EHS

Embrace the dynamic world of EHS – the cutting-edge technology that stands for Extra High Speed, redefining the norms of the industry. As the sole fully copper bonded technology for all three metal positions, EHS represents the pinnacle of innovation. It proudly holds the crown as the fastest technology available in the market, empowering clients to achieve remarkable speeds of up to 15,000mm/min (590 inch/min). Symbolizing the very essence of our company, EHS embodies unparalleled efficiency and breakthrough performance. Step into the future of stone fabrication with EHS, where speed and precision converge, setting the stage for unprecedented success and transforming your projects like never before.

### Performance



### Suitable for:

- ▲ Granite
- Ceramic and Quartz
- Marble

### Position:

- 1 - Profiling
- 2 - Profiling
- 3 - Profiling

### Available for:







# Zenith

Welcome to the world of Zenith – the renowned sintered technology by Marmoelettromeccanica, setting a new standard of excellence. Versatility is at its core, as Zenith seamlessly adapts to all materials, making it the go-to choice for both CNC and manual router bits, known as the Professional series. With exceptional performance as its hallmark, Zenith delivers unparalleled results that elevate your stone fabrication endeavors to new heights. Embrace the precision and reliability that only Zenith can provide, as it effortlessly carves its way through any task with unrivaled proficiency. Step into a realm of cutting-edge innovation and experience the zenith of stone processing technology.

Zenith seamlessly adapts to all materials, making it the go-to choice.

### Performance



### Suitable for:

- ▲ Granite
- Ceramic and Quartz
- Marble

### Position:

- 1 - Profiling
- 2 - Profiling

### Available for:

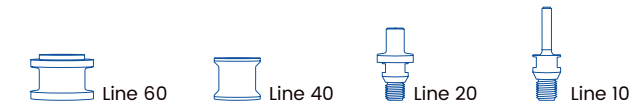



A specialized diamond tooling innovation tailor-made for soft materials like marble and travertine.



# Electroplated

Electroplated – a specialized diamond tooling innovation tailor-made for soft materials like marble and travertine. Its unique nature offers a softness of cut, making it a preferred choice for delicate applications on these materials, ensuring precision and finesse. Furthermore, Electroplated technology shines as a hero for super brittle materials, as its gentle touch prevents excessive chipping and fractures during cutting. While it excels in handling softer substances, its adaptability extends to handling even the most fragile materials with grace. Embrace the precision, delicacy, and versatility of Electroplated tools, designed to carve a flawless path through soft and super brittle materials alike.

### Performance



### Suitable for:

- Marble

### Position:

- 1 - Profiling
- 2 - Profiling

### Available for:





# BiPower

BiPower technology – the triumphant third position complementing Zenith, the epitome of innovation. Aptly named for its double duty prowess, BiPower completes the profiling process while simultaneously initiating polishing, making it an indispensable asset in the stone industry. Universally adaptable, this remarkable technology can flawlessly tackle any material, showcasing its versatility and exceptional performance across the spectrum. Embrace the power of BiPower as it revolutionizes your stone fabrication endeavors, seamlessly transitioning from profiling to polishing with unmatched efficiency. Unlock the potential of this game-changing technology and elevate your projects to unprecedented levels of perfection and finesse.

BiPower completes the profiling process while simultaneously initiating polishing.



### Performance



### Position:

3 - Profiling

### Available for:



### Suitable for:

- ▲ Granite
- Ceramic and Quartz
- Marble

**NEW  
PRODUCT**



3.0 mm  
Diamond thickness



**Performance**



**Suitable for:**

- ▲ Granite
- Ceramic and Quartz
- Marble

**Position:**

- 4 - Polishing
- 5 - Polishing
- 6 - Polishing

**Available for:**



# Glossforce 3.0

Glossforce 3.0 polishers – a patented technology that transcends traditional polishing methods. Redefining the industry's landscape, Glossforce goes beyond mere improvements to diamond and resin bonds, completely transforming the structure of the tools themselves. The incorporation of a hybrid intermediate material ensures a fully homogeneous finish across the entire profile shape, setting a new standard for flawless polishing precision. As the pioneering member of a new generation of polishers, Glossforce emerges as the ultimate choice, boasting not only the highest polish achievable but also unparalleled longevity, guaranteeing exceptional performance that stands the test of time.



Step into the forefront of cutting-edge polishing with Glossforce, where innovation meets excellence. Experience the power of a fully perfected finish, crafted with precision and care, as Glossforce delivers unmatched brilliance and longevity. Embrace the future of polishing technology, elevating your projects to the pinnacle of shine and durability. With Glossforce, the highest polish and extended tool life become more than just possibilities – they become your reality.





# Longlife+

Longlife+ Polishers – the trailblazing pioneers of diamond resin bonded polishing wheels. As the very first of their kind in the industry, these remarkable tools continue to set the bar for excellence, delivering an unparalleled level of polish that remains unrivaled to this day. With a legacy of innovation that spans generations, Longlife Polishers showcase their enduring brilliance by consistently achieving the highest polish attainable in the stone industry. Embrace the cutting-edge technology that started it all, as Longlife Polishers elevate your stone polishing endeavors to extraordinary levels of shine, precision, and enduring quality.



1.0 mm  
Diamond thickness

### Performance



### Suitable for:

- ▲ Granite
- Ceramic and Quartz
- Marble

### Position:

- 4 - Polishing
- 5 - Polishing
- 6 - Polishing

### Available for:

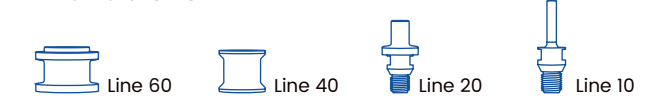

# Technologies Overview

## Frangistone

Crafted with multiple discs featuring small spaces in between, these awe-inspiring breakers are the ultimate epitome of efficiency and precision.

## Segmented

Segmented technology, a prevailing innovation in the stone fabrication industry, stands as a cornerstone of sintered advancements

## EHS

It proudly holds the crown as the fastest technology available in the market, empowering clients to achieve remarkable speeds of up to 15,000mm/min (590 inch/min).

## Electroplated

*Electroplated* – a specialized diamond tooling innovation tailor-made for soft materials like marble and travertine. Its unique nature offers a softness of cut, making it a preferred choice for delicate applications.

## Glossforce3.0

Glossforce emerges as the ultimate choice, boasting not only the highest polish achievable but also unparalleled longevity, guaranteeing exceptional performance that stands the test of time.

## Razorstone

Without any gaps between its blades, this precut marvel redefines precision, delivering an impeccable, finer finish that leaves spectators in awe.

## Hyper-Z

Behold the sheer strength of these diamond bonds as Hyper tools outshine competitors, boasting an impressive six-fold increase in lifespan while performing tasks at a jaw-dropping five times the speed.

## Zenith

Versatility is at its core, as Zenith seamlessly adapts to all materials, making it the go-to choice for both CNC and manual router bits, known as the Professional series.

## BiPower

*BiPower technology* – the triumphant third position complementing Zenith, the epitome of innovation. Aptly named for its double duty prowess, BiPower completes the profiling process while simultaneously initiating polishing.

## Longlife+

With a legacy of innovation that spans generations, Longlife Polishers showcase their enduring brilliance by consistently achieving the highest polish attainable in the stone industry.

00  
Breaker

Frangistone  
■ ● ▲

0  
Pre-cutting

Razorstone  
■ ● ▲

Hyper-Z  
■ ● ▲

Segmented  
■ ▲

1  
Profiling

EHS  
■ ● ▲  
Zenith  
■ ● ▲  
Electroplated  
●

2  
Profiling

EHS  
■ ● ▲  
Zenith  
■ ● ▲  
Electroplated  
●

3  
Profiling

EHS  
■ ● ▲  
BiPower  
■ ● ▲

4  
Polishing

Longlife+  
■ ● ▲  
Glossforce 3.0  
■ ● ▲

5  
Polishing

Longlife+  
■ ● ▲  
Glossforce 3.0  
■ ● ▲

6  
Polishing

Longlife+  
■ ● ▲  
Glossforce 3.0  
■ ● ▲



### Z-Axis Alignment

Set up kit in a few minutes



### 100% In-House Production

Both for diamond and polishing tools



### Customized Grinding Wheels

Production in a few days



### Low Maintenance Tools

No need to EDM the tools



### Increased Diamond Thickness

Extended lifespan



### Perfect Polishing

Highest gloss on all materials

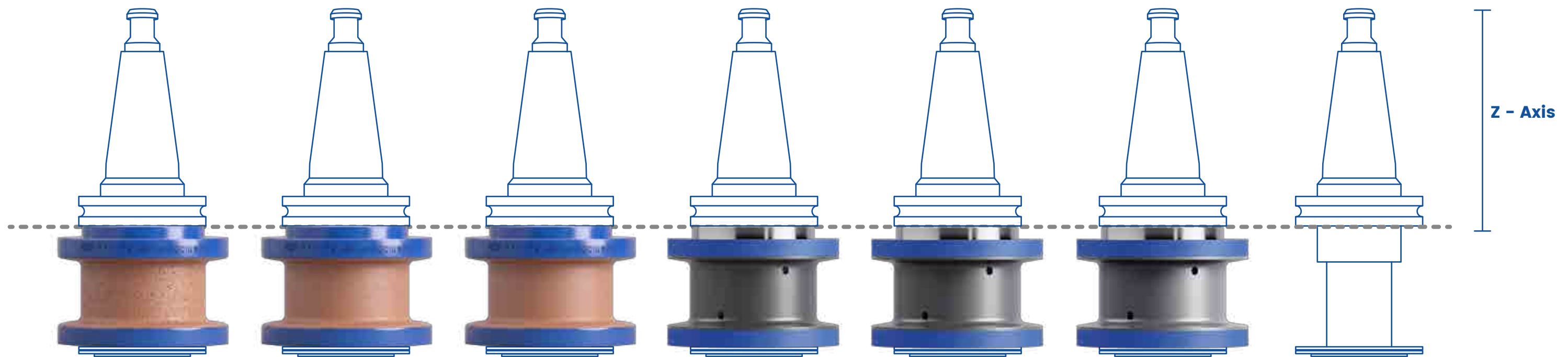

**Z-Axis Alignment. Calibrated height on all positions for easy set up.**

# Advantages

# Profiles Overview



	ID CODE	PAGE LINE 60	PAGE LINE 40	PAGE LINE 20
A20 r5	001	66	108	126
A20 r5 pfd	320	-	-	126
A20 r5 DEC	523	-	108	126
A20 r5 pfd DEC	321	-	-	127
A20 r10	002	66	-	127
A30 r3	004	66	108	127
A30 r3 pfd	011	-	-	128
A30 r3 DEC	239	-	109	128
A30 r3 pfd DEC	339	-	-	128
A30 r5	005	67	109	129
A30 r5 pfd	012	-	-	129
A30 r5 DEC	D521	-	-	129
A30 r5 pfd DEC	199	67	109	130
A30 r6	006	67	110	130
A30 r6 pfd	013	-	-	130
A30 r6 pfd DEC	186	68	-	-
A30 r8	007	68	-	-
A30 r10	008	68	-	-
A30 r10 pfd DEC	196	69	-	-
A30 r15	009	69	-	-
A30 r15 pfd DEC	187	69	-	-
A30 r20	010	70	-	-
A40 r3 pfd	245	-	-	131
A40 r5	240	-	-	131
A40 r5 pfd	342	-	-	131
A40 r20	021	70	-	-



B20	026	70	-	-
B30	027	71	-	-
B30 pfd DEC	188	71	-	-
B40	150	71	-	-



C30	089	72	-	-
C40	370	72	-	-



D20	311	72	-	-
D30	312	73	-	-
D40	314	73	-	-



E20 12x12	045	73	-	-
E30 20x20	046	74	-	-
E30 8x8	361	74	-	-
E30 8x8 pfd DEC	419	74	-	-
E30 12x12	062	75	-	-
E40 24x24	047	75	-	-



	ID CODE	PAGE LINE 60	PAGE LINE 40	PAGE LINE 20
F20	049	75	-	-
F30	050	76	-	-
F30 pfd DEC	190	76	-	-



FZ30 r10	074	76	-	-
FZ30 pfd DEC	193	77	-	-
FZ40 r15	076	77	-	-
FZ40 r10	174	77	-	-



G30	054	78	-	-
-----	-----	----	---	---



H20	056	78	-	-
H30	057	78	-	-
H30 pfd DEC	191	79	-	-
H40	058	79	-	-



H+A20	059	79	-	-
H+A30	060	80	-	-



L20	064	80	-	-
L30	065	80	-	-



M30	068	81	-	-
M30 pfd DEC	192	81	-	-



O20	070	81	-	-
O30	071	82	-	-
O40	072	82	-	-



OG20	153	82	-	-
OG30	154	83	-	-



Q20	077	83	-	-
Q30	078	83	-	-
Q40	079	84	-	-



	ID CODE	PAGE LINE 60	PAGE LINE 40	PAGE LINE 20
T12 r2.5	168	84	110	132
T12 r5	243	84	-	132
T20 r3	114	85	110	132
T20 r5	080	85	111	133
T30 r3	115	85	111	133
T30 r3 30°	422	86	-	-
T30 r4	444	86	111	133
T30 r5	082	86	112	134
T30 r6	156	87	112	134
T30 r8	D096	87	112	134
T30 r10	081	87	-	-
T32 r3	017	-	-	135
T40 r3.5	117	88	113	135
T40 r5	084	88	-	135



	ID CODE	PAGE LINE 60	PAGE LINE 40	PAGE LINE 20
Z20	033	96	-	139
Z30	034	96	116	139
Z40	035	97	116	139
Z50	036	97	-	140
Z60	037	97	-	-



ZS20	040	98	-	-
ZS30	041	98	116	140
ZS30 pfd	043	-	-	140
ZS40	042	98	117	141
ZS40 pfd	044	-	-	141



TP20	029	88	-	-
TP30	030	89	-	-
TP30 pfd DEC	189	89	-	-



V12	265	89	-	-
V20	087	90	-	-
V30	088	90	-	-
V40	090	90	-	-
V50	092	91	-	-
V60	093	91	-	-



V+Q30	103	91	-	-
V+Q40	104	92	-	-



X+D12	110	92	-	136
X+D20	108	92	-	-
X+D30	109	93	-	-
X+D40	111	93	-	-



YS12 1.5x1.5	D191	93	113	136
YS20 1.5x1.5	D028	94	114	136
YS20 2x2	D283	94	114	137
YS20 3x3	120	94	114	137
YS30 1.5x1.5	D445	95	115	137
YS30 2x2	122	95	115	138
YS30 3x3	121	95	115	138
YS40 3x3	124	96	-	138

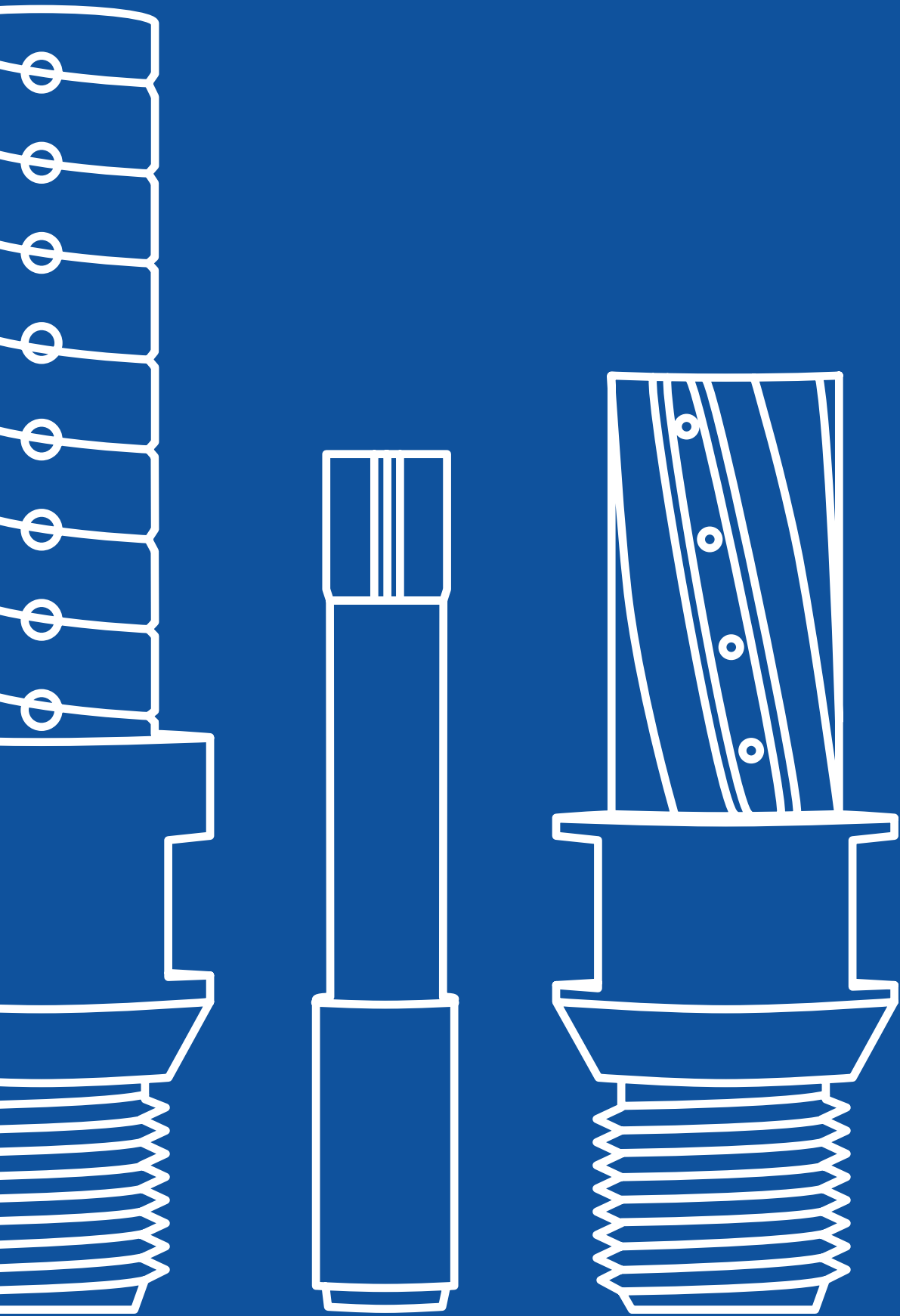

An extensive selection of finger bits caters to various cutting needs, ranging from sintered ones with segments for granite and engineered stones to electroplated options ideal for marble and stone. Each finger bit is meticulously crafted using modern and innovative sintered and electroplated processes. With exceptional cutting power and remarkable durability, these finger bits offer the best price-to-quality ratio, ensuring optimum performance and value for your stone cutting endeavors.

# Finger-bits



Gold Line - Universal

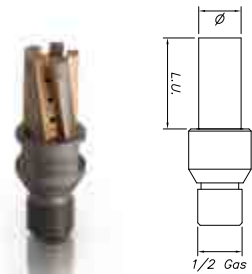

CODE	DESCRIPTION
SC01005	H25 - Ø23
SC01006	H35 - Ø23
SC01007	H50 - Ø23

Electroplated

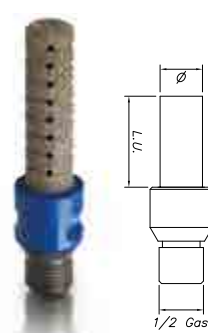

CODE	DESCRIPTION
SC01012	Ø16 - H40 (HELICAL)
SC01013	Ø16 - H55 (HELICAL)
SC01105	Ø16 - H60 (HELICAL)
SC01014	Ø20 - H65 (HELICAL)
SC01015	Ø23 - H100 (HELICAL)

CODE	DESCRIPTION
SC01080	Ø16 - H40 (FLAT)
SC01181	Ø16 - H55 (FLAT)
SC01182	Ø20 - H65 (FLAT)
SC01183	Ø23 - H100 (FLAT)

Orange Line - Quartz

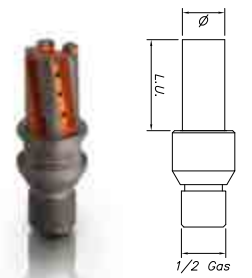

CODE	DESCRIPTION
SC01057	H35 - Ø23
SC01058	H50 - Ø23

Micro Incremental - Sink Flush

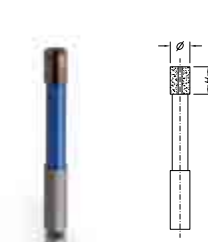

CODE	DESCRIPTION
SC01346	Ø10 - H10
SC01348	Ø10 - H10+20
SC01347	Ø20 - H20

Shs Red Line - High Speed Universal

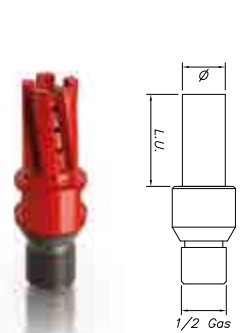

CODE	DESCRIPTION
SCS01006	H35
SCS01007	H50

Incremental Bit

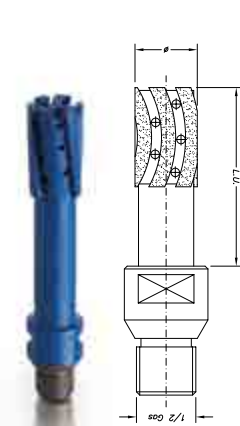

CODE	DESCRIPTION
SC01037	Ø28 - H48
SC01038	Ø28 - H48 - L90
SC01039	Ø28 - H48 - L120

Blue line



CODE	DESCRIPTION
SC01334	H40

Incremental Crown - Sintered

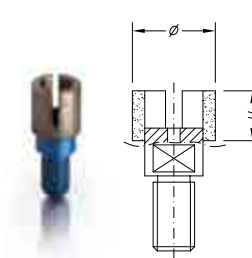

CODE	DESCRIPTION	FITTING
SC01020	Ø20 - M10	M10
SC01341	Ø20 - M10	M10 LEFT
SC01021	Ø20 - M12	M12
SC01335	Ø20 - M12	M12 LEFT

Incremental Crown - Electroplated

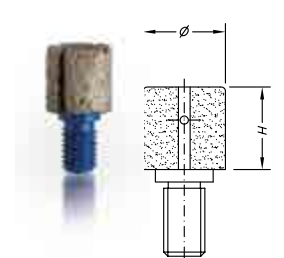

CODE	DESCRIPTION	FITTING
SC01331	Ø20 - M10	M10
SC01337	Ø20 - M10	M10 LEFT
SC01336	Ø20 - M12	M12
SC01335	Ø20 - M12	M12 LEFT

Extension

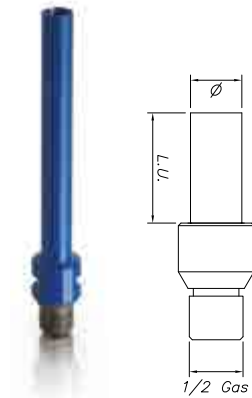

CODE	DESCRIPTION	FITTING
SA01023	Ø18 - H55 - M10	1/2" Gas
SA01024	Ø18 - H90 - M10	1/2" Gas
SA01025	Ø18 - H120 - M10	1/2" Gas
SA01026	Ø18 - H150 - M10	1/2" Gas
SA01027	Ø18 - H200 - M10	1/2" Gas
SA01540	Ø18 - H55 - M10 LEFT	1/2" Gas
SA01541	Ø18 - H90 - M10 LEFT	1/2" Gas
SA01542	Ø18 - H120 - M10 LEFT	1/2" Gas
SA01543	Ø18 - H150 - M10 LEFT	1/2" Gas
SA01544	Ø18 - H200 - M10 LEFT	1/2" Gas
SA01535	Ø18 - H55 - M10 LEFT	1/2" Gas LEFT
SA01545	Ø18 - H90 - M10 LEFT	1/2" Gas LEFT
SA01546	Ø18 - H120 - M10 LEFT	1/2" Gas LEFT
SA01547	Ø18 - H150 - M10 LEFT	1/2" Gas LEFT
SA01548	Ø18 - H200 - M10 LEFT	1/2" Gas LEFT

CODE	DESCRIPTION	FITTING
SA01028	Ø18 - H55 - M12	1/2" Gas
SA01029	Ø18 - H90 - M12	1/2" Gas
SA01030	Ø18 - H120 - M12	1/2" Gas
SA01031	Ø18 - H150 - M12	1/2" Gas
SA01032	Ø18 - H200 - M12	1/2" Gas
SA01549	Ø18 - H55 - M12 LEFT	1/2" Gas
SA01550	Ø18 - H90 - M12 LEFT	1/2" Gas
SA01551	Ø18 - H120 - M12 LEFT	1/2" Gas
SA01552	Ø18 - H150 - M12 LEFT	1/2" Gas
SA01553	Ø18 - H200 - M12 LEFT	1/2" Gas
SA01508	Ø18 - H55 - M12 LEFT	1/2" Gas LEFT
SA01529	Ø18 - H90 - M12 LEFT	1/2" Gas LEFT
SA01509	Ø18 - H120 - M12 LEFT	1/2" Gas LEFT
SA01510	Ø18 - H150 - M12 LEFT	1/2" Gas LEFT
SA01511	Ø18 - H200 - M12 LEFT	1/2" Gas LEFT

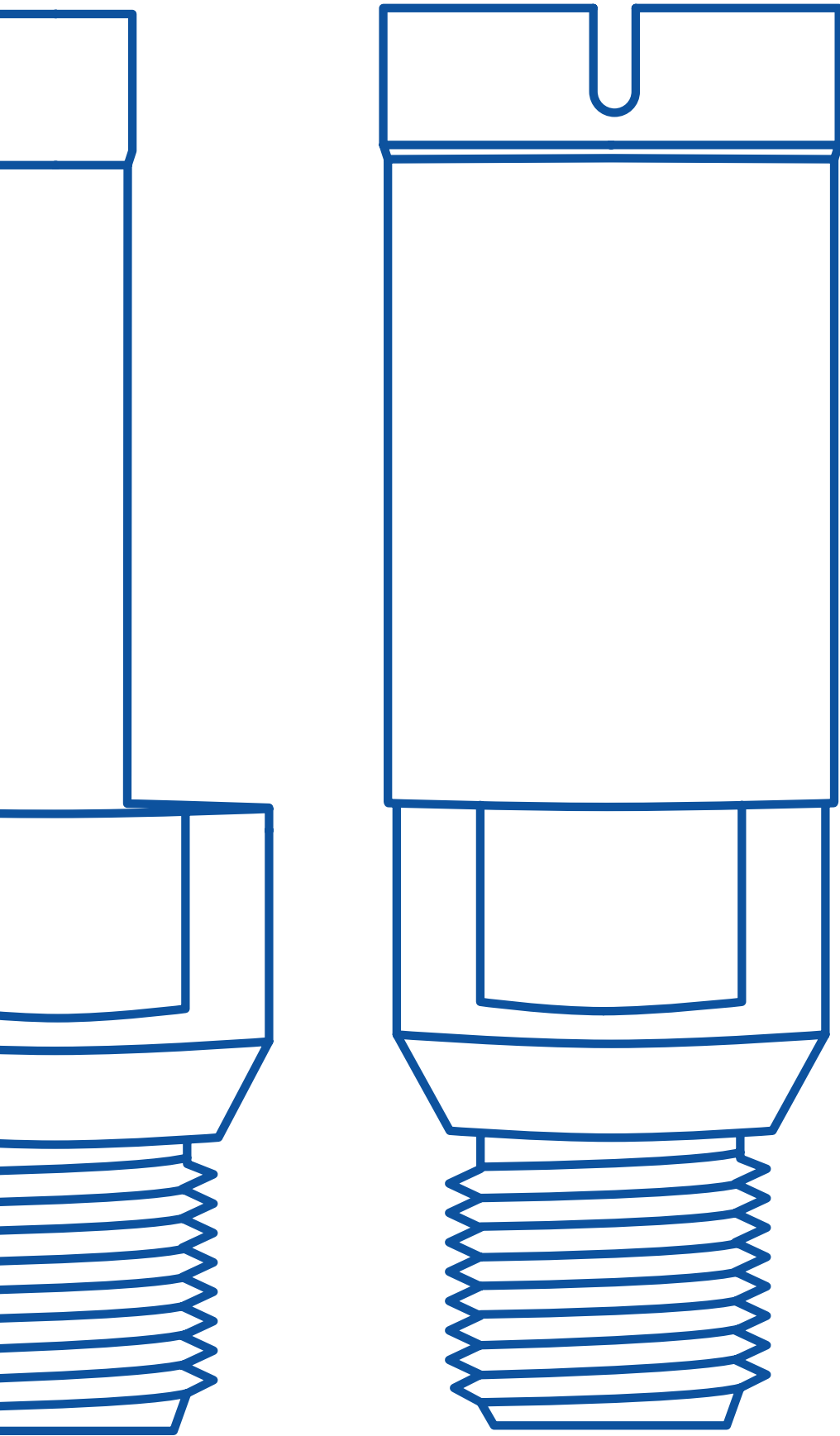

Explore an extensive array of core drills designed to excel during the drilling phase. Whether you require sintered core drills with segments for granite and engineered stones or electroplated options suitable for marble, our selection has you covered. Each core drill is meticulously crafted using modern and innovative sintered and electroplated processes. With exceptional cutting power and impressive longevity, these core drills offer an unbeatable price-to-quality ratio, delivering outstanding performance and value for your drilling operations.

# Core Drills





SHS thin Crown



CODE	DESCRIPTION
SC02019	Ø10
SC02076	Ø15
SC02084	Ø16
SC02013	Ø20
SC02007	Ø25
SC02008	Ø30
SC02009	Ø32
SC02010	Ø35
SC02011	Ø38
SC02012	Ø40
SC02037	Ø45
SC02066	Ø50
SC02067	Ø60
SC02099	Ø65
SC02080	Ø70
SC02081	Ø80
SC02082	Ø90
SC02083	Ø100

Left Hand Thread Fitting

CODE	DESCRIPTION
SC02110	Ø10
SC02101	Ø16
SC02114	Ø20
SC02111	Ø25
SC02118	Ø30
SC02105	Ø32
SC02102	Ø35
SC02106	Ø38
SC02103	Ø40
SC02108	Ø45
SC02115	Ø50
SC02119	Ø60
SC02104	Ø65
SC02112	Ø70
SC02113	Ø80
SC02116	Ø90
SC02117	Ø100

Sintered for blind holes



CODE	DESCRIPTION
SC02069	Ø6
SC02071	Ø7
SC02072	Ø8
SC02073	Ø10
SC02074	Ø12
SC02075	Ø14
SC02076	Ø15

Segmented

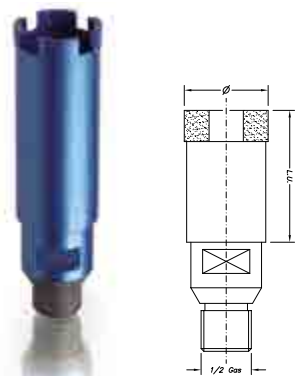

CODE	DESCRIPTION
SC02005	Ø35 - H70
SC02061	Ø35 - H56
SC02064	Ø50 - H70

Electroplated

CODE	DESCRIPTION
SC02001	Ø20



Discover precision and speed with Line 60, our flagship CNC profiling wheels. Engineered with a 60mm minimum diameter, this line offers external profiling excellence for stone countertops. Achieve remarkable feed rates and a flawless 30mm internal radius. With options in EHS, Standard, and Electroplated technologies, Line 60 ensures consistency and efficiency in sinkhole creation. Seamlessly integrate using a 35mm bore fitting. Please note that for simple flat profiles, the pre-cutting option may not apply. Elevate your countertop fabrication with Line 60's cutting-edge performance.

Unleash creativity. We welcome custom profiles, fitting tweaks, and Electroplated technology. Elevate your CNC experience with tailored precision.

The Line 60 sets are available in larger diameters too, please ask our team for further information [ha il menu contestuale](#).

# Line 60



**EHS Kit**  
High Speed, Universal

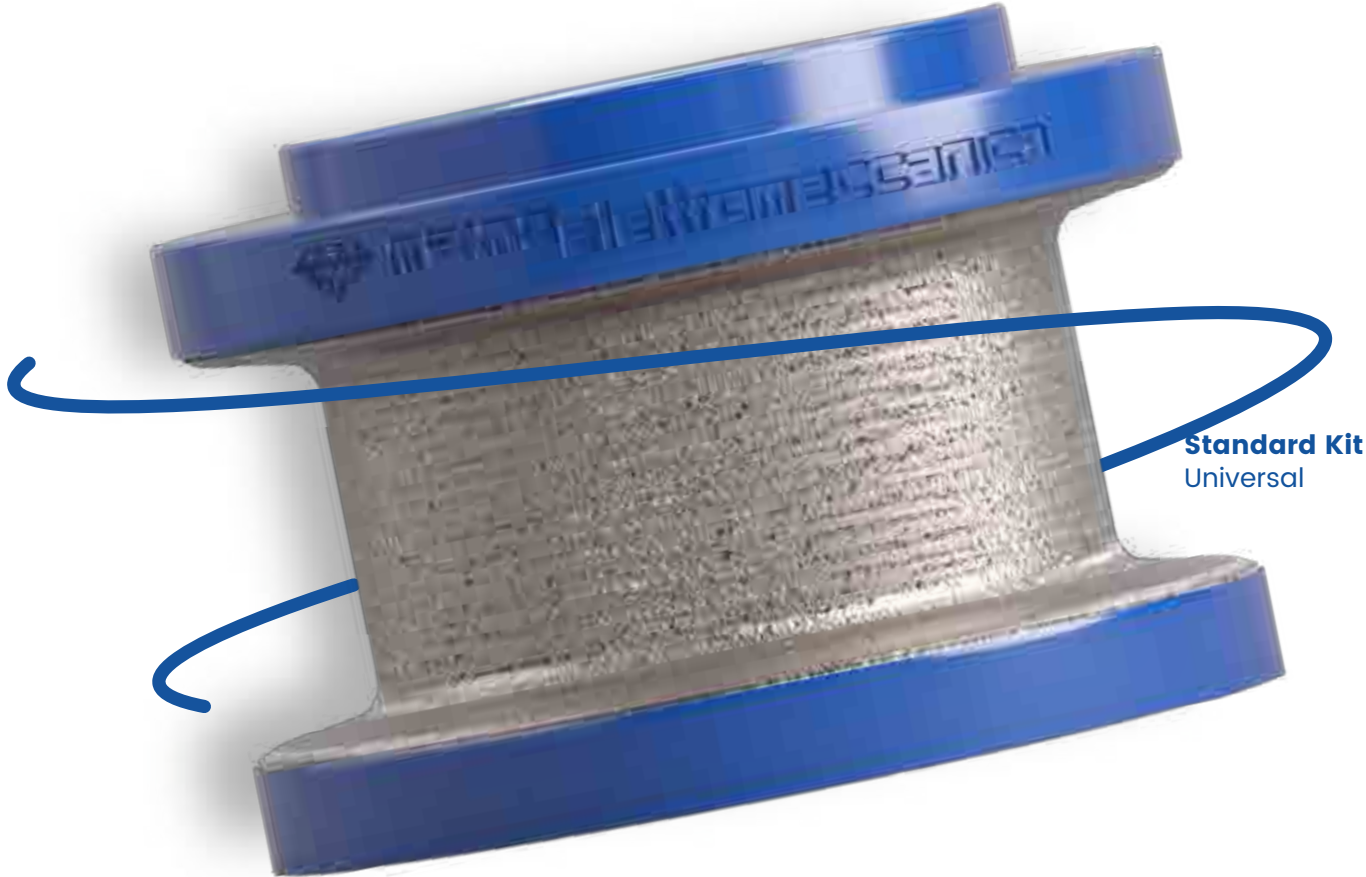

**Standard Kit**  
Universal



**Electroplated Kit**  
Marble

**00**

Breaker

**0**

Pre-cutting



**FRANGISTONE**  
For granite, ceramic and quartz



**RAZORSTONE**  
For granite, ceramic and quartz



**Hyper-Z**  
For granite, ceramic and quartz

# Position



1

Profiling

2

Profiling

3

Profiling

4

Polishing

5

Polishing

6

Polishing

EHS Kit



**EHS - Extra High Speed**  
Universal

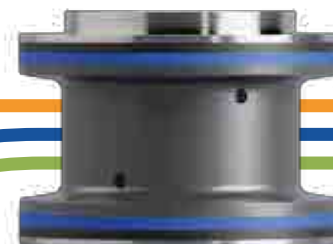

**GLOSSFORCE 3.0**  
Universal



Standard Kit



**ZENITH**  
Universal



**BIPOWER**  
Universal

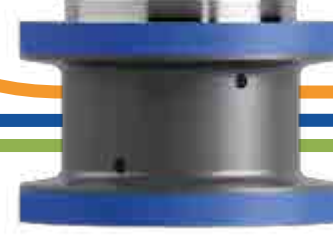

**LONGLIFE+**  
Universal



Electroplated Kit



**ELECTROPLATED**  
Marble

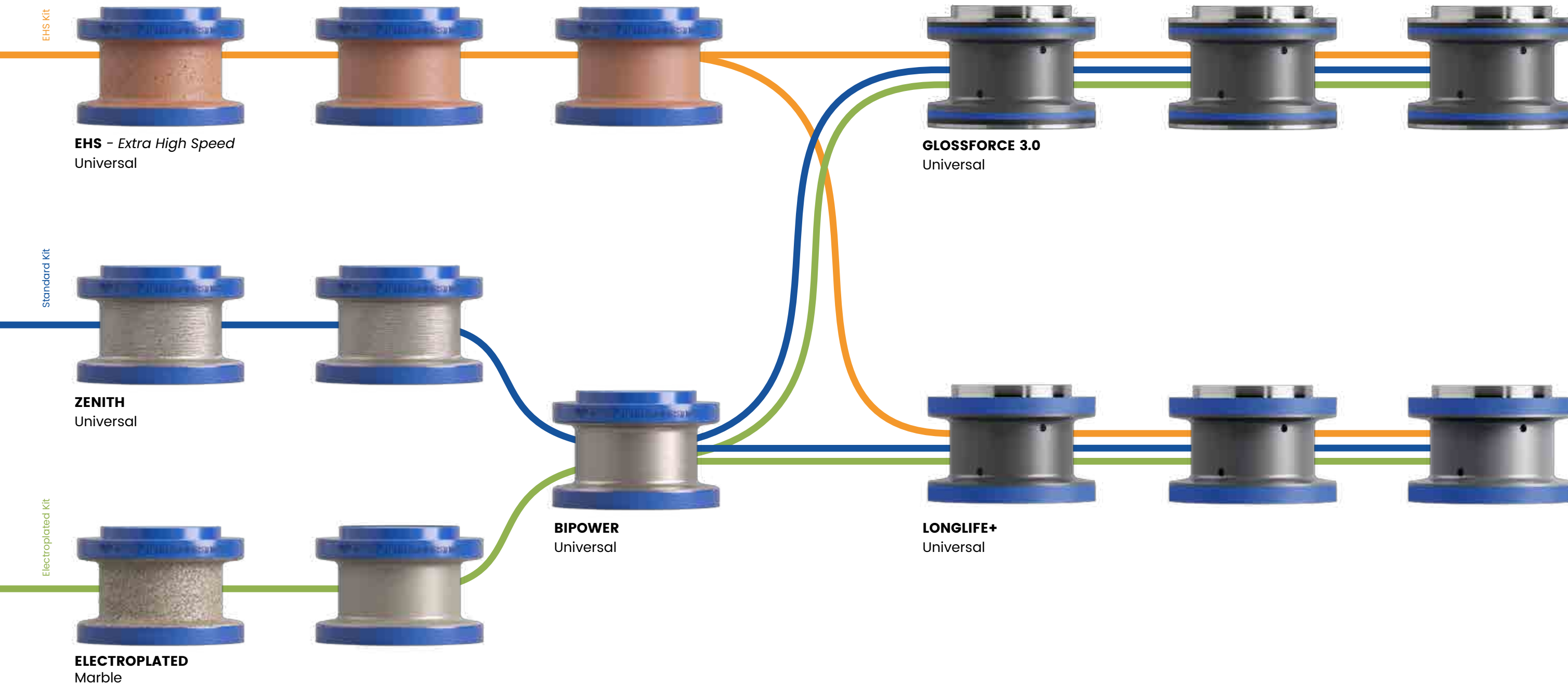



# Line 60 Profiles

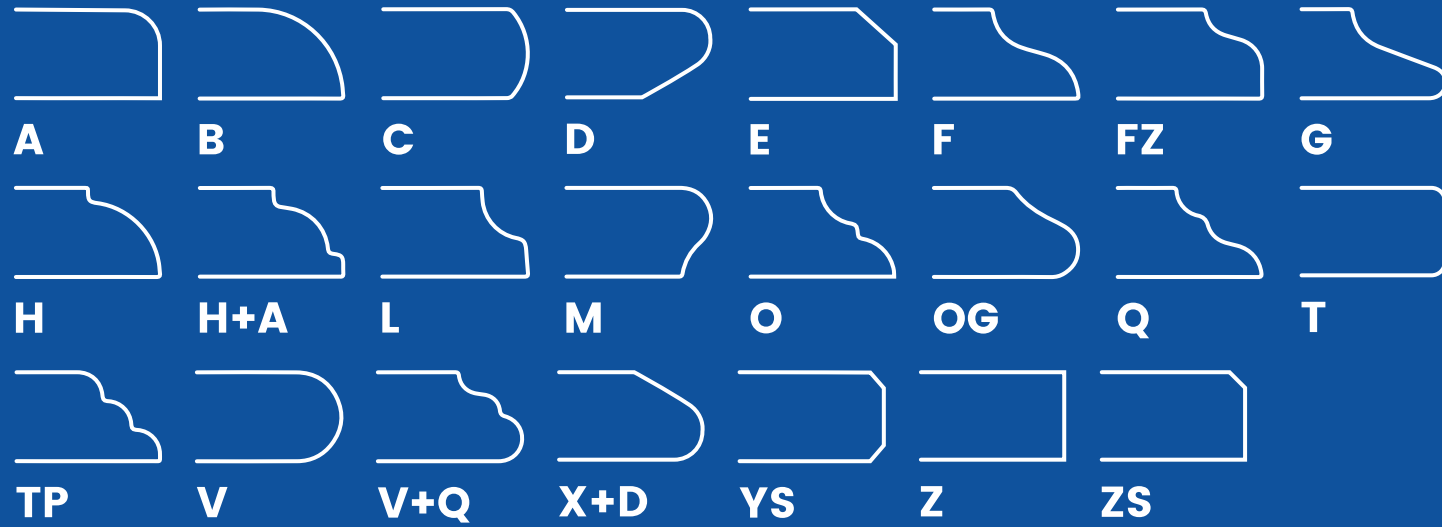

\* Custom designed profiles are accepted

## Hyper-Z



HYPER Z CLEANER			
POS.	CODE	DESCRIPTION	FITTING
CLEANER	SC01400	Ø62 - H45	Bore 35
CLEANER	SC01401	Ø62 - H65	Bore 35

## Miter Tools



Set designed to achieve the bevel miter at 45°. Bore 35 mm.

Miter Tools 30mm			Miter Tools 40mm		
POS.	CODE	DESCRIPTION	POS.	CODE	DESCRIPTION
00	SC72149	Frangistone	00	SC72256	Frangistone
0	SC60257	Segmented	0	SC60256	Segmented
1	SC61257	Zenith	1	SC61256	Zenith
2	SC62257	Zenith	2	SC62256	Zenith
3	SC63257	BiPower	3	SC63256	BiPower
4	SC64257	Longlife	4	SC64256	Longlife
5	SC65257	Longlife	5	SC65256	Longlife
6	SC66257	Longlife	6	SC66256	Longlife

## Seam Tools



Available also in Ø80 - Ø90 - Ø120

EHS Kit			Standard Kit			Electroplated Kit		
POS.	CODE	HEIGHT	CODE	HEIGHT	CODE	HEIGHT	CODE	HEIGHT
1	SCE61034	30mm	SC61034	30mm	SC67034	30mm	SC67034	30mm
2	SCE62034	30mm	SC62034	30mm	SC68034	30mm	SC68034	30mm
3	SCE63034	30mm	SC63034	30mm	SC63034	30mm	SC63034	30mm
-	-	-	-	-	-	-	-	-
1	SCE61035	40mm	SC61035	40mm	SC67035	40mm	SC67035	40mm
2	SCE62035	40mm	SC62035	40mm	SC68035	40mm	SC68035	40mm
3	SCE63035	40mm	SC63035	40mm	SC63035	40mm	SC63035	40mm
-	-	-	-	-	-	-	-	-
1	SCE61036	50mm	SC61036	50mm	SC67036	50mm	SC67036	50mm
2	SCE62036	50mm	SC62036	50mm	SC68036	50mm	SC68036	50mm
3	SCE63036	50mm	SC63036	50mm	SC63036	50mm	SC63036	50mm





## A20 r5

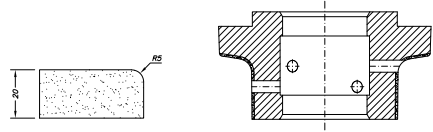

## A20 r10

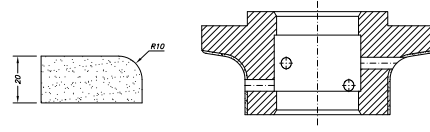

## A30 r3

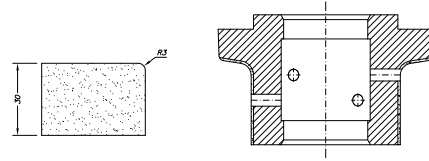

## A30 r5

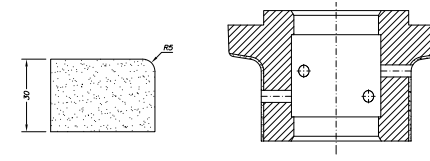

## A30 r5 Pfd DEC

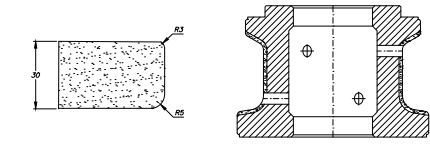

## A30 r6

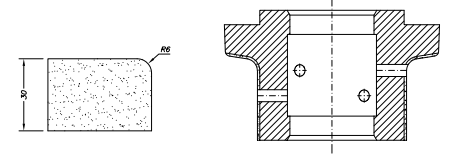

### EHS Kit ▲ ■ ●

POS.	CODE	TECHNOLOGY
00	-	-
0	-	-
1	SCE61001	EHS
2	SCE62001	EHS
3	SCE63001	EHS
4	SC64001	Longlife+
5	SC65001	Longlife+
6	SC66001	Longlife+

### EHS Kit ▲ ■ ●

CODE	TECHNOLOGY
SC72002	Frangistone
SCR72002	Razorstone
SCE61002	EHS
SCE62002	EHS
SCE63002	EHS
SC64002	Longlife+
SC65002	Longlife+
SC66002	Longlife+

### EHS Kit ▲ ■ ●

CODE	TECHNOLOGY
-	-
SCE61004	EHS
SCE62004	EHS
SCE63004	EHS
SC64004	Longlife+
SC65004	Longlife+
SC66004	Longlife+

### EHS Kit ▲ ■ ●

POS.	CODE	TECHNOLOGY
00	-	-
0	-	-
1	SCE61005	EHS
2	SCE62005	EHS
3	SCE63005	EHS
4	SC64005	Longlife+
5	SC65005	Longlife+
6	SC66005	Longlife+

### EHS Kit ▲ ■ ●

CODE	TECHNOLOGY
-	-
SCE61199	EHS
SCE62199	EHS
SCE63199	EHS
SC64199	Longlife+
SC65199	Longlife+
SC66199	Longlife+

### EHS Kit ▲ ■ ●

CODE	TECHNOLOGY
-	-
SCE61006	EHS
SCE62006	EHS
SCE63006	EHS
SC64006	Longlife+
SC65006	Longlife+
SC66006	Longlife+

### Standard Kit ▲ ■ ●

POS.	CODE	TECHNOLOGY
00	-	-
0	-	-
1	SC61001	Zenith
2	SC62001	Zenith
3	SC63001	BiPower
3X	SC6X001	XtraFine
4	SC64001	Longlife+
5	SC65001	Longlife+
6	SC66001	Longlife+

### Standard Kit ▲ ■ ●

CODE	TECHNOLOGY
SC72002	Frangistone
SCR72002	Razorstone
SC61002	Zenith
SC62002	Zenith
SC63002	BiPower
SC6X002	XtraFine
SC64002	Longlife+
SC65002	Longlife+
SC66002	Longlife+

### Standard Kit ▲ ■ ●

CODE	TECHNOLOGY
-	-
SC61004	Zenith
SC62004	Zenith
SC63004	BiPower
SC6X004	XtraFine
SC64004	Longlife+
SC65004	Longlife+
SC66004	Longlife+

### Standard Kit ▲ ■ ●

POS.	CODE	TECHNOLOGY
00	-	-
0	-	-
1	SC61005	Zenith
2	SC62005	Zenith
3	SC63005	BiPower
3X	SC6X005	XtraFine
4	SC64005	Longlife+
5	SC65005	Longlife+
6	SC66005	Longlife+

### Standard Kit ▲ ■ ●

CODE	TECHNOLOGY
-	-
SC61199	Zenith
SC62199	Zenith
SC63199	BiPower
SC6X199	XtraFine
SC64199	Longlife+
SC65199	Longlife+
SC66199	Longlife+

### Standard Kit ▲ ■ ●

CODE	TECHNOLOGY
-	-
SC61006	Zenith
SC62006	Zenith
SC63006	BiPower
SC6X006	XtraFine
SC64006	Longlife+
SC65006	Longlife+
SC66006	Longlife+

### Electroplated Kit ●

POS.	CODE	TECHNOLOGY
1	SC67001	Electroplated
2	SC68001	Electroplated
3	SC63001	BiPower
4	SC64001	Longlife+
5	SC65001	Longlife+
6	SC66001	Longlife+

### Electroplated Kit ●

CODE	TECHNOLOGY
SC67002	Electroplated
SC68002	Electroplated
SC63002	BiPower
SC64002	Longlife+
SC65002	Longlife+
SC66002	Longlife+

### Electroplated Kit ●

CODE	TECHNOLOGY
SC67004	Electroplated
SC68004	Electroplated
SC63004	BiPower
SC64004	Longlife+
SC65004	Longlife+
SC66004	Longlife+

### Electroplated Kit ●

POS.	CODE	TECHNOLOGY
1	SC67005	Electroplated
2	SC68005	Electroplated
3	SC63005	BiPower
4	SC64005	Longlife+
5	SC65005	Longlife+
6	SC66005	Longlife+

### Electroplated Kit ●

CODE	TECHNOLOGY
SC67199	Electroplated
SC68199	Electroplated
SC63199	BiPower
SC64199	Longlife+
SC65199	Longlife+
SC66199	Longlife+

### Electroplated Kit ●

CODE	TECHNOLOGY
SC67006	Electroplated
SC68006	Electroplated
SC63006	BiPower
SC64006	Longlife+
SC65006	Longlife+
SC66006	Longlife+

### Glossforce3.0

POS.	CODE	TECHNOLOGY
4	SCG64004	GlossForce 3.0
5	SCG65004	GlossForce 3.0
6	SCG66004	GlossForce 3.0



## A30 r6 Pfd DEC

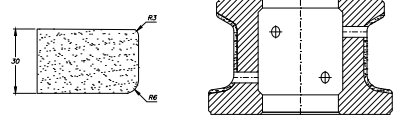

## A30 r8

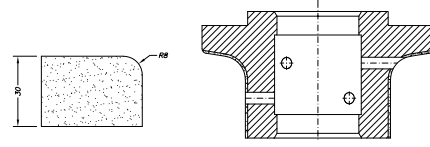

## A30 r10

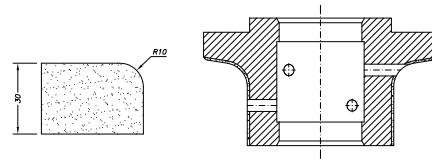

## A30 r10 Pfd DEC

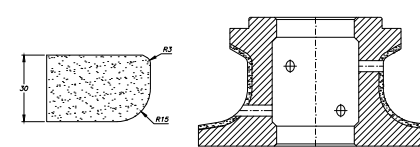

## A30 r15

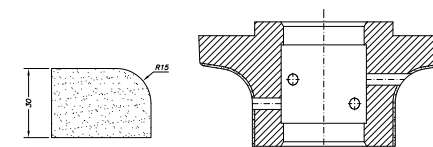

## A30 r15 Pfd DEC

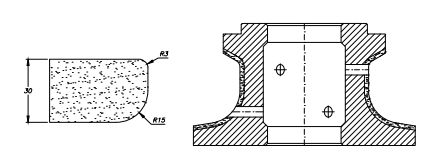

### EHS Kit ▲ ■ ●

POS.	CODE	TECHNOLOGY
00	-	-
0	-	-
1	SCE61186	EHS
2	SCE62186	EHS
3	SCE63186	EHS
4	SC64186	Longlife+
5	SC65186	Longlife+
6	SC66186	Longlife+

### EHS Kit ▲ ■ ●

POS.	CODE	TECHNOLOGY
00	-	-
0	-	-
1	SCE61007	EHS
2	SCE62007	EHS
3	SCE63007	EHS
4	SC64007	Longlife+
5	SC65007	Longlife+
6	SC66007	Longlife+

### EHS Kit ▲ ■ ●

POS.	CODE	TECHNOLOGY
00	SC72008	Frangistone
0	SCR72008	Razorstone
1	SCE61008	EHS
2	SCE62008	EHS
3	SCE63008	EHS
4	SC64008	Longlife+
5	SC65008	Longlife+
6	SC66008	Longlife+

### EHS Kit ▲ ■ ●

POS.	CODE	TECHNOLOGY
00	SC72196	Frangistone
0	SCR72196	Razorstone
1	SCE61196	EHS
2	SCE62196	EHS
3	SCE63196	EHS
4	SC64196	Longlife+
5	SC65196	Longlife+
6	SC66196	Longlife+

### EHS Kit ▲ ■ ●

POS.	CODE	TECHNOLOGY
00	SC72009	Frangistone
0	SCR72009	Razorstone
1	SCE61009	EHS
2	SCE62009	EHS
3	SCE63009	EHS
4	SC64009	Longlife+
5	SC65009	Longlife+
6	SC66009	Longlife+

### EHS Kit ▲ ■ ●

POS.	CODE	TECHNOLOGY
00	SC72187	Frangistone
0	SCR72187	Razorstone
1	SCE61187	EHS
2	SCE62187	EHS
3	SCE63187	EHS
4	SC64187	Longlife+
5	SC65187	Longlife+
6	SC66187	Longlife+

### Standard Kit ▲ ■ ●

POS.	CODE	TECHNOLOGY
00	-	-
0	-	-
1	SC61186	Zenith
2	SC62186	Zenith
3	SC63186	BiPower
3X	SC6X186	XtraFine
4	SC64186	Longlife+
5	SC65186	Longlife+
6	SC66186	Longlife+

### Standard Kit ▲ ■ ●

POS.	CODE	TECHNOLOGY
00	-	-
0	-	-
1	SC61007	Zenith
2	SC62007	Zenith
3	SC63007	BiPower
3X	SC6X007	XtraFine
4	SC64007	Longlife+
5	SC65007	Longlife+
6	SC66007	Longlife+

### Standard Kit ▲ ■ ●

POS.	CODE	TECHNOLOGY
00	SC72008	Frangistone
0	SCR72008	Razorstone
1	SC61008	Zenith
2	SC62008	Zenith
3	SC63008	BiPower
3X	SC6X008	XtraFine
4	SC64008	Longlife+
5	SC65008	Longlife+
6	SC66008	Longlife+

### Standard Kit ▲ ■ ●

POS.	CODE	TECHNOLOGY
00	SC72196	Frangistone
0	SCR72196	Razorstone
1	SC61196	Zenith
2	SC62196	Zenith
3	SC63196	BiPower
3X	SC6X196	XtraFine
4	SC64196	Longlife+
5	SC65196	Longlife+
6	SC66196	Longlife+

### Standard Kit ▲ ■ ●

POS.	CODE	TECHNOLOGY
00	SC72009	Frangistone
0	SCR72009	Razorstone
1	SC61009	Zenith
2	SC62009	Zenith
3	SC63009	BiPower
3X	SC6X009	XtraFine
4	SC64009	Longlife+
5	SC65009	Longlife+
6	SC66009	Longlife+

### Standard Kit ▲ ■ ●

POS.	CODE	TECHNOLOGY
00	SC72187	Frangistone
0	SCR72187	Razorstone
1	SC61187	Zenith
2	SC62187	Zenith
3	SC63187	BiPower
3X	SC6X187	XtraFine
4	SC64187	Longlife+
5	SC65187	Longlife+
6	SC66187	Longlife+

### Electroplated Kit ●

POS.	CODE	TECHNOLOGY
1	SC67186	Electroplated
2	SC68186	Electroplated
3	SC63186	BiPower
4	SC64186	Longlife+
5	SC65186	Longlife+
6	SC66186	Longlife+

### Electroplated Kit ●

POS.	CODE	TECHNOLOGY
1	SC67007	Electroplated
2	SC68007	Electroplated
3	SC63007	BiPower
4	SC64007	Longlife+
5	SC65007	Longlife+
6	SC66007	Longlife+

### Electroplated Kit ●

POS.	CODE	TECHNOLOGY
1	SC67008	Electroplated
2	SC68008	Electroplated
3	SC63008	BiPower
4	SC64008	Longlife+
5	SC65008	Longlife+
6	SC66008	Longlife+

### Electroplated Kit ●

POS.	CODE	TECHNOLOGY
1	SC67196	Electroplated
2	SC68196	Electroplated
3	SC63196	BiPower
4	SC64196	Longlife+
5	SC65196	Longlife+
6	SC66196	Longlife+

### Electroplated Kit ●

POS.	CODE	TECHNOLOGY
1	SC67009	Electroplated
2	SC68009	Electroplated
3	SC63009	BiPower
4	SC64009	Longlife+
5	SC65009	Longlife+
6	SC66009	Longlife+

### Electroplated Kit ●

POS.	CODE	TECHNOLOGY
1	SC67187	Electroplated
2	SC68187	Electroplated
3	SC63187	BiPower
4	SC64187	Longlife+
5	SC65187	Longlife+
6	SC66187	Longlife+

### Glossforce3.0

POS.	CODE	TECHNOLOGY
4	SCG64186	GlossForce 3.0
5	SCG65186	GlossForce 3.0
6	SCG66186	GlossForce 3.0

POS.
4
5
6

### Glossforce3.0

POS.	CODE	TECHNOLOGY
4	SCG64187	GlossForce 3.0
5	SCG65187	GlossForce 3.0
6	SCG66187	GlossForce 3.0



## A30 r20

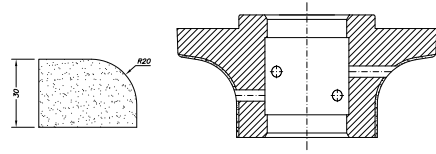

## A40 r20

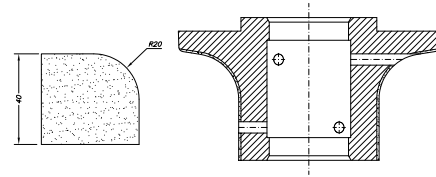

## B20

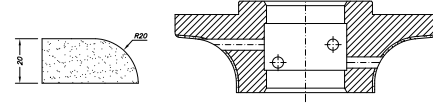

## B30

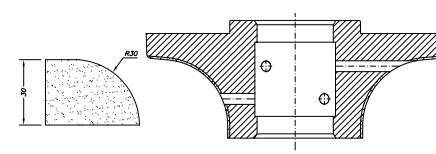

## B30 Pfd DEC

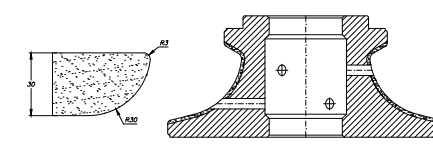

## B40

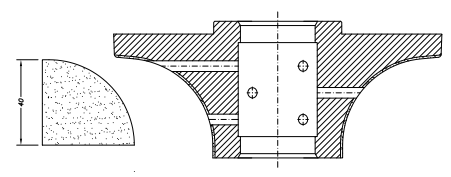

### EHS Kit ▲ ■ ●

POS.	CODE	TECHNOLOGY
00	SC72010	Frangistone
0	SCR72010	Razorstone
1	SCE61010	EHS
2	SCE62010	EHS
3	SCE63010	EHS
4	SC64010	Longlife+
5	SC65010	Longlife+
6	SC66010	Longlife+

### EHS Kit ▲ ■ ●

POS.	CODE	TECHNOLOGY
00	SC72021	Frangistone
0	SCR72021	Razorstone
1	SCE61021	EHS
2	SCE62021	EHS
3	SCE63021	EHS
4	SC64021	Longlife+
5	SC65021	Longlife+
6	SC66021	Longlife+

### EHS Kit ▲ ■ ●

POS.	CODE	TECHNOLOGY
00	SC72026	Frangistone
0	SCR72026	Razorstone
1	SCE61026	EHS
2	SCE62026	EHS
3	SCE63026	EHS
4	SC64026	Longlife+
5	SC65026	Longlife+
6	SC66026	Longlife+

### EHS Kit ▲ ■ ●

POS.	CODE	TECHNOLOGY
00	SC72027	Frangistone
0	SCR72027	Razorstone
1	SCE61027	EHS
2	SCE62027	EHS
3	SCE63027	EHS
4	SC64027	Longlife+
5	SC65027	Longlife+
6	SC66027	Longlife+

### EHS Kit ▲ ■ ●

POS.	CODE	TECHNOLOGY
00	SC72188	Frangistone
0	SCR72188	Razorstone
1	SCE61188	EHS
2	SCE62188	EHS
3	SCE63188	EHS
4	SC64188	Longlife+
5	SC65188	Longlife+
6	SC66188	Longlife+

### EHS Kit ▲ ■ ●

POS.	CODE	TECHNOLOGY
00	SC72150	Frangistone
0	SCR72150	Segmented
1	SCE61150	EHS
2	SCE62150	EHS
3	SCE63150	EHS
4	SC64150	Longlife+
5	SC65150	Longlife+
6	SC66150	Longlife+

### Standard Kit ▲ ■ ●

POS.	CODE	TECHNOLOGY
00	SC72010	Frangistone
0	SCR72010	Razorstone
1	SC61010	Zenith
2	SC62010	Zenith
3	SC63010	BiPower
3X	SC6X010	XtraFine
4	SC64010	Longlife+
5	SC65010	Longlife+
6	SC66010	Longlife+

### Standard Kit ▲ ■ ●

POS.	CODE	TECHNOLOGY
00	SC72021	Frangistone
0	SCR72021	Razorstone
1	SC61021	Zenith
2	SC62021	Zenith
3	SC63021	BiPower
3X	SC6X021	XtraFine
4	SC64021	Longlife+
5	SC65021	Longlife+
6	SC66021	Longlife+

### Standard Kit ▲ ■ ●

POS.	CODE	TECHNOLOGY
00	SC72026	Frangistone
0	SCR72026	Razorstone
1	SC61026	Zenith
2	SC62026	Zenith
3	SC63026	BiPower
3X	SC6X026	XtraFine
4	SC64026	Longlife+
5	SC65026	Longlife+
6	SC66026	Longlife+

### Standard Kit ▲ ■ ●

POS.	CODE	TECHNOLOGY
00	SC72027	Frangistone
0	SCR72027	Razorstone
1	SC61027	Zenith
2	SC62027	Zenith
3	SC63027	BiPower
3X	SC6X027	XtraFine
4	SC64027	Longlife+
5	SC65027	Longlife+
6	SC66027	Longlife+

### Standard Kit ▲ ■ ●

POS.	CODE	TECHNOLOGY
00	SC72188	Frangistone
0	SCR72188	Razorstone
1	SC61188	Zenith
2	SC62188	Zenith
3	SC63188	BiPower
3X	SC6X188	XtraFine
4	SC64188	Longlife+
5	SC65188	Longlife+
6	SC66188	Longlife+

### Standard Kit ▲ ■ ●

POS.	CODE	TECHNOLOGY
00	SC72150	Frangistone
0	SCR72150	Segmented
1	SC61150	Zenith
2	SC62150	Zenith
3	SC63150	BiPower
3X	SC6X150	XtraFine
4	SC64150	Longlife+
5	SC65150	Longlife+
6	SC66150	Longlife+

### Electroplated Kit ●

POS.	CODE	TECHNOLOGY
1	SC67010	Electroplated
2	SC68010	Electroplated
3	SC63010	BiPower
4	SC64010	Longlife+
5	SC65010	Longlife+
6	SC66010	Longlife+

### Electroplated Kit ●

POS.	CODE	TECHNOLOGY
1	SC67021	Electroplated
2	SC68021	Electroplated
3	SC63021	BiPower
4	SC64021	Longlife+
5	SC65021	Longlife+
6	SC66021	Longlife+

### Electroplated Kit ●

POS.	CODE	TECHNOLOGY
1	SC67026	Electroplated
2	SC68026	Electroplated
3	SC63026	BiPower
4	SC64026	Longlife+
5	SC65026	Longlife+
6	SC66026	Longlife+

### Electroplated Kit ●

POS.	CODE	TECHNOLOGY
1	SC67027	Electroplated
2	SC68027	Electroplated
3	SC63027	BiPower
4	SC64027	Longlife+
5	SC65027	Longlife+
6	SC66027	Longlife+

### Electroplated Kit ●

POS.	CODE	TECHNOLOGY
1	SC67188	Electroplated
2	SC68188	Electroplated
3	SC63188	BiPower
4	SC64188	Longlife+
5	SC65188	Longlife+
6	SC66188	Longlife+

### Electroplated Kit ●

POS.	CODE	TECHNOLOGY
1	SC67150	Electroplated
2	SC68150	Electroplated
3	SC63150	BiPower
4	SC64150	Longlife+
5	SC65150	Longlife+
6	SC66150	Longlife+





### C30

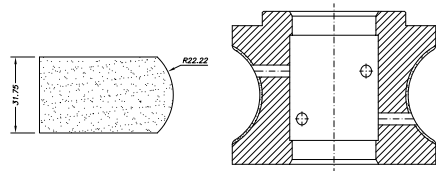

### C40

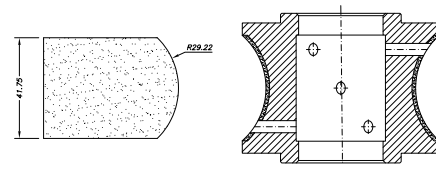

### D20

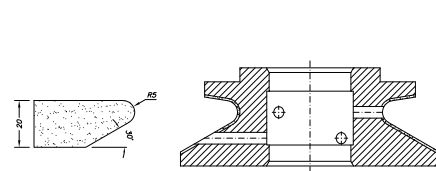

### D30

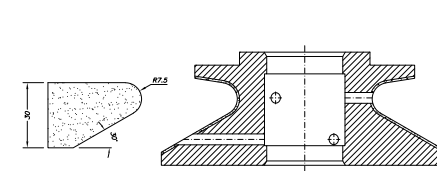

### D40

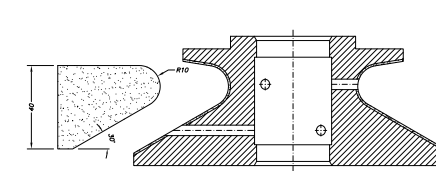

### E20 12x12

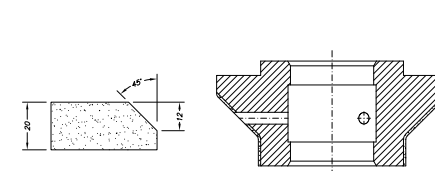

**EHS Kit** ▲ ■ ●

POS.	CODE	TECHNOLOGY
00	SC72089	Frangistone
0	SCR72089	Razorstone
1	SCE61089	EHS
2	SCE62089	EHS
3	SCE63089	EHS
4	SC64089	Longlife+
5	SC65089	Longlife+
6	SC66089	Longlife+

**EHS Kit** ▲ ■ ●

CODE	TECHNOLOGY
SC72D370	Frangistone
SCR72D370	Razorstone
SCE61D370	EHS
SCE62D370	EHS
SCE63D370	EHS
SC64D370	Longlife+
SC65D370	Longlife+
SC66D370	Longlife+

**EHS Kit** ▲ ■ ●

CODE	TECHNOLOGY
SC72311	Frangistone
SCR72311	Razorstone
SCE61311	EHS
SCE62311	EHS
SCE63311	EHS
SC64311	Longlife+
SC65311	Longlife+
SC66311	Longlife+

**EHS Kit** ▲ ■ ●

POS.	CODE	TECHNOLOGY
00	SC72312	Frangistone
0	SCR72312	Razorstone
1	SCE61312	EHS
2	SCE62312	EHS
3	SCE63312	EHS
4	SC64312	Longlife+
5	SC65312	Longlife+
6	SC66312	Longlife+

**EHS Kit** ▲ ■ ●

CODE	TECHNOLOGY
SC72314	Frangistone
SCR72314	Razorstone
SCE61314	EHS
SCE62314	EHS
SCE63314	EHS
SC64314	Longlife+
SC65314	Longlife+
SC66314	Longlife+

**EHS Kit** ▲ ■ ●

CODE	TECHNOLOGY
SC72045	Frangistone
SCR72045	Razorstone
SCE61045	EHS
SCE62045	EHS
SCE63045	EHS
SC64045	Longlife+
SC65045	Longlife+
SC66045	Longlife+

**Standard Kit** ▲ ■ ●

POS.	CODE	TECHNOLOGY
00	SC72089	Frangistone
0	SCR72089	Razorstone
1	SC61089	Zenith
2	SC62089	Zenith
3	SC63089	BiPower
3X	SC6X089	XtraFine
4	SC64089	Longlife+
5	SC65089	Longlife+
6	SC66089	Longlife+

**Standard Kit** ▲ ■ ●

CODE	TECHNOLOGY
SC72D370	Frangistone
SCR72D370	Razorstone
SC61D370	Zenith
SC62D370	Zenith
SC63D370	BiPower
SC6XD370	XtraFine
SC64D370	Longlife+
SC65D370	Longlife+
SC66D370	Longlife+

**Standard Kit** ▲ ■ ●

CODE	TECHNOLOGY
SC72311	Frangistone
SCR72311	Razorstone
SC61311	Zenith
SC62311	Zenith
SC63311	BiPower
SC6X311	XtraFine
SC64311	Longlife+
SC65311	Longlife+
SC66311	Longlife+

**Standard Kit** ▲ ■ ●

POS.	CODE	TECHNOLOGY
00	SC72312	Frangistone
0	SCR72312	Razorstone
1	SC61312	Zenith
2	SC62312	Zenith
3	SC63312	BiPower
3X	SC6X312	XtraFine
4	SC64312	Longlife+
5	SC65312	Longlife+
6	SC66312	Longlife+

**Standard Kit** ▲ ■ ●

CODE	TECHNOLOGY
SC72314	Frangistone
SCR72314	Razorstone
SC61314	Zenith
SC62314	Zenith
SC63314	BiPower
SC6X314	XtraFine
SC64314	Longlife+
SC65314	Longlife+
SC66314	Longlife+

**Standard Kit** ▲ ■ ●

CODE	TECHNOLOGY
SC72045	Frangistone
SCR72045	Razorstone
SC61045	Zenith
SC62045	Zenith
SC63045	BiPower
SC6X045	XtraFine
SC64045	Longlife+
SC65045	Longlife+
SC66045	Longlife+

**Electroplated Kit** ●

POS.	CODE	TECHNOLOGY
1	SC67089	Electroplated
2	SC68089	Electroplated
3	SC63089	BiPower
4	SC64089	Longlife+
5	SC65089	Longlife+
6	SC66089	Longlife+

**Electroplated Kit** ●

CODE	TECHNOLOGY
SC67D370	Electroplated
SC68D370	Electroplated
SC63D370	BiPower
SC64D370	Longlife+
SC65D370	Longlife+
SC66D370	Longlife+

**Electroplated Kit** ●

CODE	TECHNOLOGY
SC67311	Electroplated
SC68311	Electroplated
SC63311	BiPower
SC64311	Longlife+
SC65311	Longlife+
SC66311	Longlife+

**Electroplated Kit** ●

POS.	CODE	TECHNOLOGY
1	SC67312	Electroplated
2	SC68312	Electroplated
3	SC63312	BiPower
4	SC64312	Longlife+
5	SC65312	Longlife+
6	SC66312	Longlife+

**Electroplated Kit** ●

CODE	TECHNOLOGY
SC67314	Electroplated
SC68314	Electroplated
SC63314	BiPower
SC64314	Longlife+
SC65314	Longlife+
SC66314	Longlife+

**Electroplated Kit** ●

CODE	TECHNOLOGY
SC67045	Electroplated
SC68045	Electroplated
SC63045	BiPower
SC64045	Longlife+
SC65045	Longlife+
SC66045	Longlife+



## E30 20x20

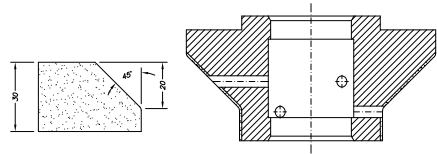

## E30 8x8

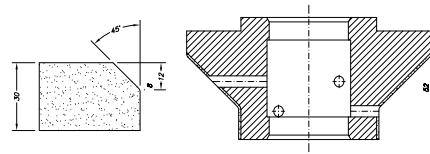

## E30 8x8 Pfd DEC

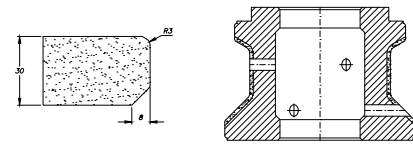

## E30 12x12

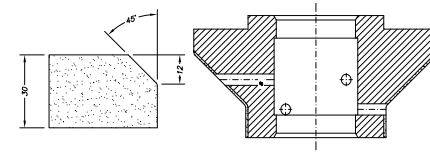

## E40 24x24

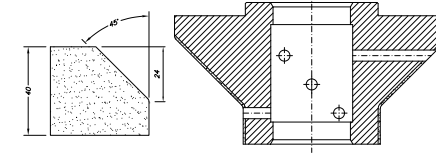

## F20

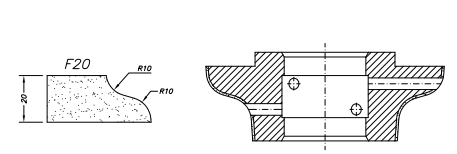

### EHS Kit ▲ ■ ●

POS.	CODE	TECHNOLOGY
00	SC72046	Frangistone
0	SC60046	Segmented
1	SCE61046	EHS
2	SCE62046	EHS
3	SCE63046	EHS
4	SC64046	Longlife+
5	SC65046	Longlife+
6	SC66046	Longlife+

### EHS Kit ▲ ■ ●

CODE	TECHNOLOGY
SC72D361	Frangistone
SC60D361	Segmented
SCE61D361	EHS
SCE62D361	EHS
SCE63D361	EHS
SC64D361	Longlife+
SC65D361	Longlife+
SC66D361	Longlife+

### EHS Kit ▲ ■ ●

CODE	TECHNOLOGY
SC72D419	Frangistone
SCR72D419	Razorstone
SCE61D419	EHS
SCE62D419	EHS
SCE63D419	EHS
SC64D419	Longlife+
SC65D419	Longlife+
SC66D419	Longlife+

### EHS Kit ▲ ■ ●

POS.	CODE	TECHNOLOGY
00	SC72D062	Frangistone
0	SCR72D062	Razorstone
1	SCE61D062	EHS
2	SCE62D062	EHS
3	SCE63D062	EHS
4	SC64D062	Longlife+
5	SC65D062	Longlife+
6	SC66D062	Longlife+

### EHS Kit ▲ ■ ●

CODE	TECHNOLOGY
SC72047	Frangistone
SC60047	Segmented
SCE61047	EHS
SCE62047	EHS
SCE63047	EHS
SC64047	Longlife+
SC65047	Longlife+
SC66047	Longlife+

### EHS Kit ▲ ■ ●

CODE	TECHNOLOGY
SC72049	Frangistone
SCR72049	Razorstone
SCE61049	EHS
SCE62049	EHS
SCE63049	EHS
SC64049	Longlife+
SC65049	Longlife+
SC66049	Longlife+

### Standard Kit ▲ ■ ●

POS.	CODE	TECHNOLOGY
00	SC72046	Frangistone
0	SC60046	Razorstone
1	SC61046	Zenith
2	SC62046	Zenith
3	SC63046	BiPower
3X	SC6X046	XtraFine
4	SC64046	Longlife+
5	SC65046	Longlife+
6	SC66046	Longlife+

### Standard Kit ▲ ■ ●

CODE	TECHNOLOGY
SC72D361	Frangistone
SC60D361	Segmented
SC61D361	Zenith
SC62D361	Zenith
SC63D361	BiPower
SC6XD361	XtraFine
SC65D361	Longlife+
SC66D361	Longlife+

### Standard Kit ▲ ■ ●

CODE	TECHNOLOGY
SC72D419	Frangistone
SCR72D419	Razorstone
SC61D419	Zenith
SC62D419	Zenith
SC63D419	BiPower
SC6XD419	XtraFine
SC64D419	Longlife+
SC65D419	Longlife+
SC66D419	Longlife+

### Standard Kit ▲ ■ ●

POS.	CODE	TECHNOLOGY
00	SC72D062	Frangistone
0	SCR72D062	Razorstone
1	SC61D062	Zenith
2	SC62D062	Zenith
3	SC63D062	BiPower
3X	SC6XD062	XtraFine
4	SC64D062	Longlife+
5	SC65D062	Longlife+
6	SC66D062	Longlife+

### Standard Kit ▲ ■ ●

CODE	TECHNOLOGY
SC72047	Frangistone
SC60047	Segmented
SC61047	Zenith
SC62047	Zenith
SC63047	BiPower
SC6X047	XtraFine
SC64047	Longlife+
SC65047	Longlife+
SC66047	Longlife+

### Standard Kit ▲ ■ ●

CODE	TECHNOLOGY
SC72049	Frangistone
SCR72049	Razorstone
SC61049	Zenith
SC62049	Zenith
SC63049	BiPower
SC6X049	XtraFine
SC64049	Longlife+
SC65049	Longlife+
SC66049	Longlife+

### Electroplated Kit ●

POS.	CODE	TECHNOLOGY
1	SC67046	Electroplated
2	SC68046	Electroplated
3	SC63046	BiPower
4	SC64046	Longlife+
5	SC65046	Longlife+
6	SC66046	Longlife+

### Electroplated Kit ●

CODE	TECHNOLOGY
SC67D361	Electroplated
SC68D361	Electroplated
SC63D361	BiPower
SC65D361	Longlife+
SC66D361	Longlife+

### Electroplated Kit ●

CODE	TECHNOLOGY
SC67D419	Electroplated
SC68D419	Electroplated
SC63D419	BiPower
SC64D419	Longlife+
SC65D419	Longlife+
SC66D419	Longlife+

### Electroplated Kit ●

POS.	CODE	TECHNOLOGY
1	SC67D062	Electroplated
2	SC68D062	Electroplated
3	SC63D062	BiPower
4	SC64D062	Longlife+
5	SC65D062	Longlife+
6	SC66D062	Longlife+

### Electroplated Kit ●

CODE	TECHNOLOGY
SC67047	Electroplated
SC68047	Electroplated
SC63047	BiPower
SC64047	Longlife+
SC65047	Longlife+
SC66047	Longlife+

### Electroplated Kit ●

CODE	TECHNOLOGY
SC67049	Electroplated
SC68049	Electroplated
SC63049	BiPower
SC64049	Longlife+
SC65049	Longlife+
SC66049	Longlife+



## F30

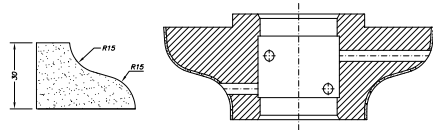

## F30 Pfd DEC

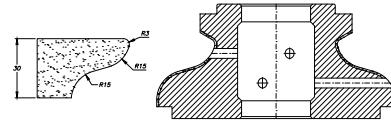

## FZ30 r10

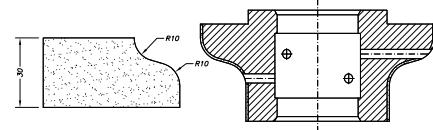

## FZ30 Pfd DEC

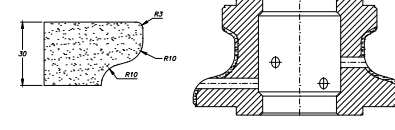

## FZ40 r15

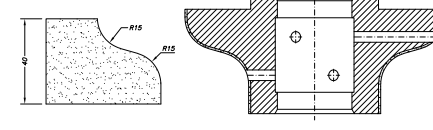

## FZ40 r10

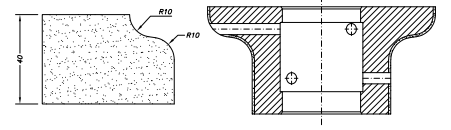

### EHS Kit ▲ ■ ●

POS.	CODE	TECHNOLOGY
00	SC72050	Frangistone
0	SCR72050	Razorstone
1	SCE61050	EHS
2	SCE62050	EHS
3	SCE63050	EHS
4	SC64050	Longlife+
5	SC65050	Longlife+
6	SC66050	Longlife+

### EHS Kit ▲ ■ ●

POS.	CODE	TECHNOLOGY
00	SC72190	Frangistone
0	SCR72190	Segmented
1	SCE61190	EHS
2	SCE62190	EHS
3	SCE63190	EHS
4	SC64190	Longlife+
5	SC65190	Longlife+
6	SC66190	Longlife+

### EHS Kit ▲ ■ ●

POS.	CODE	TECHNOLOGY
00	SC72074	Frangistone
0	SCR72074	Razorstone
1	SCE61074	EHS
2	SCE62074	EHS
3	SCE63074	EHS
4	SC64074	Longlife+
5	SC65074	Longlife+
6	SC66074	Longlife+

### EHS Kit ▲ ■ ●

POS.	CODE	TECHNOLOGY
00	SC72193	Frangistone
0	SCR72193	Razorstone
1	SCE61193	EHS
2	SCE62193	EHS
3	SCE63193	EHS
4	SC64193	Longlife+
5	SC65193	Longlife+
6	SC66193	Longlife+

### EHS Kit ▲ ■ ●

POS.	CODE	TECHNOLOGY
00	SC72076	Frangistone
0	SCR72076	Segmented
1	SCE61076	EHS
2	SCE62076	EHS
3	SCE63076	EHS
4	SC64076	Longlife+
5	SC65076	Longlife+
6	SC66076	Longlife+

### EHS Kit ▲ ■ ●

POS.	CODE	TECHNOLOGY
00	SC72174	Frangistone
0	SCR72174	Razorstone
1	SCE61174	EHS
2	SCE62174	EHS
3	SCE63174	EHS
4	SC64174	Longlife+
5	SC65174	Longlife+
6	SC66174	Longlife+

### Standard Kit ▲ ■ ●

POS.	CODE	TECHNOLOGY
00	SC72050	Frangistone
0	SCR72050	Razorstone
1	SC61050	Zenith
2	SC62050	Zenith
3	SC63050	BiPower
3X	SC6X050	XtraFine
4	SC64050	Longlife+
5	SC65050	Longlife+
6	SC66050	Longlife+

### Standard Kit ▲ ■ ●

POS.	CODE	TECHNOLOGY
00	SC72190	Frangistone
0	SCR72190	Segmented
1	SC61190	Zenith
2	SC62190	Zenith
3	SC63190	BiPower
3X	SC6X190	XtraFine
4	SC64190	Longlife+
5	SC65190	Longlife+
6	SC66190	Longlife+

### Standard Kit ▲ ■ ●

POS.	CODE	TECHNOLOGY
00	SC72074	Frangistone
0	SCR72074	Razorstone
1	SC61074	Zenith
2	SC62074	Zenith
3	SC63074	BiPower
3X	SC6X074	XtraFine
4	SC64074	Longlife+
5	SC65074	Longlife+
6	SC66074	Longlife+

### Standard Kit ▲ ■ ●

POS.	CODE	TECHNOLOGY
00	SC72193	Frangistone
0	SCR72193	Razorstone
1	SC61193	Zenith
2	SC62193	Zenith
3	SC63193	BiPower
3X	SC6X193	XtraFine
4	SC64193	Longlife+
5	SC65193	Longlife+
6	SC66193	Longlife+

### Standard Kit ▲ ■ ●

POS.	CODE	TECHNOLOGY
00	SC72076	Frangistone
0	SCR72076	Segmented
1	SC61076	Zenith
2	SC62076	Zenith
3	SC63076	BiPower
3X	SC6X076	XtraFine
4	SC64076	Longlife+
5	SC65076	Longlife+
6	SC66076	Longlife+

### Standard Kit ▲ ■ ●

POS.	CODE	TECHNOLOGY
00	SC72174	Frangistone
0	SCR72174	Razorstone
1	SC61174	Zenith
2	SC62174	Zenith
3	SC63174	BiPower
3X	SC6X174	XtraFine
4	SC64174	Longlife+
5	SC65174	Longlife+
6	SC66174	Longlife+

### Electroplated Kit ●

POS.	CODE	TECHNOLOGY
1	SC67050	Electroplated
2	SC68050	Electroplated
3	SC63050	BiPower
4	SC64050	Longlife+
5	SC65050	Longlife+
6	SC66050	Longlife+

### Electroplated Kit ●

POS.	CODE	TECHNOLOGY
1	SC67190	Electroplated
2	SC68190	Electroplated
3	SC63190	BiPower
4	SC64190	Longlife+
5	SC65190	Longlife+
6	SC66190	Longlife+

### Electroplated Kit ●

POS.	CODE	TECHNOLOGY
1	SC67074	Electroplated
2	SC68074	Electroplated
3	SC63074	BiPower
4	SC64074	Longlife+
5	SC65074	Longlife+
6	SC66074	Longlife+

### Electroplated Kit ●

POS.	CODE	TECHNOLOGY
1	SC67193	Electroplated
2	SC68193	Electroplated
3	SC63193	BiPower
4	SC64193	Longlife+
5	SC65193	Longlife+
6	SC66193	Longlife+

### Electroplated Kit ●

POS.	CODE	TECHNOLOGY
1	SC67076	Electroplated
2	SC68076	Electroplated
3	SC63076	BiPower
4	SC64076	Longlife+
5	SC65076	Longlife+
6	SC66076	Longlife+

### Electroplated Kit ●

POS.	CODE	TECHNOLOGY
1	SC67174	Electroplated
2	SC68174	Electroplated
3	SC63174	BiPower
4	SC64174	Longlife+
5	SC65174	Longlife+
6	SC66174	Longlife+



## G30

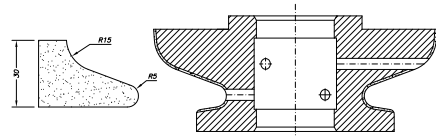

## H20

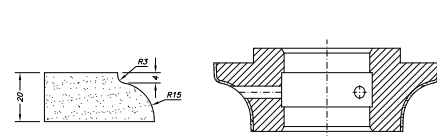

## H30

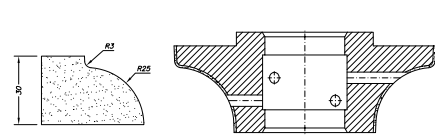

## H30 Pfd DEC

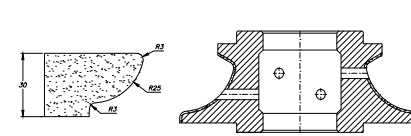

## H40

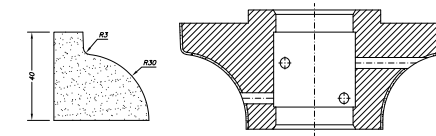

## H+A20

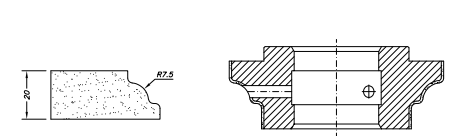

### EHS Kit ▲ ■ ●

POS.	CODE	TECHNOLOGY
00	SC72054	Frangistone
0	SCR72054	Razorstone
1	SCE61054	EHS
2	SCE62054	EHS
3	SCE63054	EHS
4	SC64054	Longlife+
5	SC65054	Longlife+
6	SC66054	Longlife+

### EHS Kit ▲ ■ ●

CODE	TECHNOLOGY
SC72056	Frangistone
SCR72056	Razorstone
SCE61056	EHS
SCE62056	EHS
SCE63056	EHS
SC64056	Longlife+
SC65056	Longlife+
SC66056	Longlife+

### EHS Kit ▲ ■ ●

CODE	TECHNOLOGY
SC72057	Frangistone
SCR72057	Razorstone
SCE61057	EHS
SCE62057	EHS
SCE63057	EHS
SC64057	Longlife+
SC65057	Longlife+
SC66057	Longlife+

### EHS Kit ▲ ■ ●

POS.	CODE	TECHNOLOGY
00	SC72191	Frangistone
0	SCR72191	Razorstone
1	SCE61191	EHS
2	SCE62191	EHS
3	SCE63191	EHS
4	SC64191	Longlife+
5	SC65191	Longlife+
6	SC66191	Longlife+

### EHS Kit ▲ ■ ●

CODE	TECHNOLOGY
SC72058	Frangistone
SC60058	Segmented
SCE61058	EHS
SCE62058	EHS
SCE63058	EHS
SC64058	Longlife+
SC65058	Longlife+
SC66058	Longlife+

### EHS Kit ▲ ■ ●

CODE	TECHNOLOGY
SC72059	Frangistone
SCR72059	Razorstone
SCE61059	EHS
SCE62059	EHS
SCE63059	EHS
SC64059	Longlife+
SC65059	Longlife+
SC66059	Longlife+

### Standard Kit ▲ ■ ●

POS.	CODE	TECHNOLOGY
00	SC72054	Frangistone
0	SCR72054	Razorstone
1	SC61054	Zenith
2	SC62054	Zenith
3	SC63054	BiPower
3X	SC6X054	XtraFine
4	SC64054	Longlife+
5	SC65054	Longlife+
6	SC66054	Longlife+

### Standard Kit ▲ ■ ●

CODE	TECHNOLOGY
SC72056	Frangistone
SCR72056	Razorstone
SC61056	Zenith
SC62056	Zenith
SC63056	BiPower
SC6X056	XtraFine
SC64056	Longlife+
SC65056	Longlife+
SC66056	Longlife+

### Standard Kit ▲ ■ ●

CODE	TECHNOLOGY
SC72057	Frangistone
SCR72057	Razorstone
SC61057	Zenith
SC62057	Zenith
SC63057	BiPower
SC6X057	XtraFine
SC64057	Longlife+
SC65057	Longlife+
SC66057	Longlife+

### Standard Kit ▲ ■ ●

POS.	CODE	TECHNOLOGY
00	SC72191	Frangistone
0	SCR72191	Razorstone
1	SC61191	Zenith
2	SC62191	Zenith
3	SC63191	BiPower
3X	SC6X191	XtraFine
4	SC64191	Longlife+
5	SC65191	Longlife+
6	SC66191	Longlife+

### Standard Kit ▲ ■ ●

CODE	TECHNOLOGY
SC72058	Frangistone
SC60058	Segmented
SC61058	Zenith
SC62058	Zenith
SC63058	BiPower
SC6X058	XtraFine
SC64058	Longlife+
SC65058	Longlife+
SC66058	Longlife+

### Standard Kit ▲ ■ ●

CODE	TECHNOLOGY
SC72059	Frangistone
SCR72059	Razorstone
SC61059	Zenith
SC62059	Zenith
SC63059	BiPower
SC6X059	XtraFine
SC64059	Longlife+
SC65059	Longlife+
SC66059	Longlife+

### Electroplated Kit ●

POS.	CODE	TECHNOLOGY
1	SC67054	Electroplated
2	SC68054	Electroplated
3	SC63054	BiPower
4	SC64054	Longlife+
5	SC65054	Longlife+
6	SC66054	Longlife+

### Electroplated Kit ●

CODE	TECHNOLOGY
SC67056	Electroplated
SC68056	Electroplated
SC63056	BiPower
SC64056	Longlife+
SC65056	Longlife+
SC66056	Longlife+

### Electroplated Kit ●

CODE	TECHNOLOGY
SC67057	Electroplated
SC68057	Electroplated
SC63057	BiPower
SC64057	Longlife+
SC65057	Longlife+
SC66057	Longlife+

### Electroplated Kit ●

POS.	CODE	TECHNOLOGY
1	SC67191	Electroplated
2	SC68191	Electroplated
3	SC63191	BiPower
4	SC64191	Longlife+
5	SC65191	Longlife+
6	SC66191	Longlife+

### Electroplated Kit ●

CODE	TECHNOLOGY
SC67058	Electroplated
SC68058	Electroplated
SC63058	BiPower
SC64058	Longlife+
SC65058	Longlife+
SC66058	Longlife+

### Electroplated Kit ●

CODE	TECHNOLOGY
SC67059	Electroplated
SC68059	Electroplated
SC63059	BiPower
SC64059	Longlife+
SC65059	Longlife+
SC66059	Longlife+



## H+A30

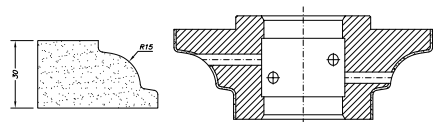

## L20

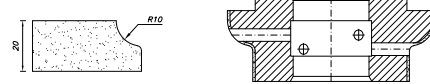

## L30



## M30

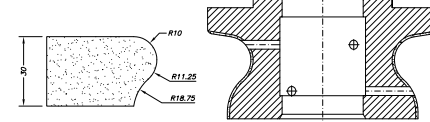

## M30 Pfd DEC

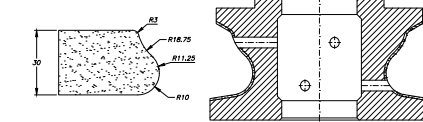

## O20

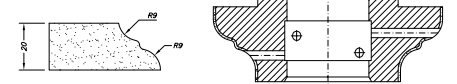

### EHS Kit ▲ ■ ●

POS.	CODE	TECHNOLOGY
00	SC72060	Frangistone
0	SC60060	Segmented
1	SCE61060	EHS
2	SCE62060	EHS
3	SCE63060	EHS
4	SC64060	Longlife+
5	SC65060	Longlife+
6	SC66060	Longlife+

### EHS Kit ▲ ■ ●

CODE	TECHNOLOGY
SC72064	Frangistone
SC60064	Segmented
SCE61064	EHS
SCE62064	EHS
SCE63064	EHS
SC64064	Longlife+
SC65064	Longlife+
SC66064	Longlife+

### EHS Kit ▲ ■ ●

CODE	TECHNOLOGY
SC72065	Frangistone
SC60065	Segmented
SCE61065	EHS
SCE62065	EHS
SCE63065	EHS
SC64065	Longlife+
SC65065	Longlife+
SC66065	Longlife+

### EHS Kit ▲ ■ ●

POS.	CODE	TECHNOLOGY
00	SC72068	Frangistone
0	SC60068	Segmented
1	SCE61068	EHS
2	SCE62068	EHS
3	SCE63068	EHS
4	SC64068	Longlife+
5	SC65068	Longlife+
6	SC66068	Longlife+

### EHS Kit ▲ ■ ●

CODE	TECHNOLOGY
SC72192	Frangistone
SCR72192	Segmented
SCE61192	EHS
SCE62192	EHS
SCE63192	EHS
SC64192	Longlife+
SC65192	Longlife+
SC66192	Longlife+

### EHS Kit ▲ ■ ●

CODE	TECHNOLOGY
SC72070	Frangistone
SCR72070	Razorstone
SCE61070	EHS
SCE62070	EHS
SCE63070	EHS
SC64070	Longlife+
SC65070	Longlife+
SC66070	Longlife+

### Standard Kit ▲ ■ ●

POS.	CODE	TECHNOLOGY
00	SC72060	Frangistone
0	SC60060	Segmented
1	SC61060	Zenith
2	SC62060	Zenith
3	SC63060	BiPower
3X	SC6X060	XtraFine
4	SC64060	Longlife+
5	SC65060	Longlife+
6	SC66060	Longlife+

### Standard Kit ▲ ■ ●

CODE	TECHNOLOGY
SC72064	Frangistone
SC60064	Segmented
SC61064	Zenith
SC62064	Zenith
SC63064	BiPower
SC6X064	XtraFine
SC64064	Longlife+
SC65064	Longlife+
SC66064	Longlife+

### Standard Kit ▲ ■ ●

CODE	TECHNOLOGY
SC72065	Frangistone
SC60065	Segmented
SC61065	Zenith
SC62065	Zenith
SC63065	BiPower
SC6X065	XtraFine
SC64065	Longlife+
SC65065	Longlife+
SC66065	Longlife+

### Standard Kit ▲ ■ ●

POS.	CODE	TECHNOLOGY
00	SC72068	Frangistone
0	SC60068	Segmented
1	SC61068	Zenith
2	SC62068	Zenith
3	SC63068	BiPower
3X	SC6X068	XtraFine
4	SC64068	Longlife+
5	SC65068	Longlife+
6	SC66068	Longlife+

### Standard Kit ▲ ■ ●

CODE	TECHNOLOGY
SC72192	Frangistone
SCR72192	Segmented
SC61192	Zenith
SC62192	Zenith
SC63192	BiPower
SC6X192	XtraFine
SC64192	Longlife+
SC65192	Longlife+
SC66192	Longlife+

### Standard Kit ▲ ■ ●

CODE	TECHNOLOGY
SC72070	Frangistone
SCR72070	Razorstone
SC61070	Zenith
SC62070	Zenith
SC63070	BiPower
SC6X070	XtraFine
SC64070	Longlife+
SC65070	Longlife+
SC66070	Longlife+

### Electroplated Kit ●

POS.	CODE	TECHNOLOGY
1	SC67060	Electroplated
2	SC68060	Electroplated
3	SC63060	BiPower
4	SC64060	Longlife+
5	SC65060	Longlife+
6	SC66060	Longlife+

### Electroplated Kit ●

CODE	TECHNOLOGY
SC67064	Electroplated
SC68064	Electroplated
SC63064	BiPower
SC64064	Longlife+
SC65064	Longlife+
SC66064	Longlife+

### Electroplated Kit ●

CODE	TECHNOLOGY
SC67065	Electroplated
SC68065	Electroplated
SC63065	BiPower
SC64065	Longlife+
SC65065	Longlife+
SC66065	Longlife+

### Electroplated Kit ●

POS.	CODE	TECHNOLOGY
1	SC67068	Electroplated
2	SC68068	Electroplated
3	SC63068	BiPower
4	SC64068	Longlife+
5	SC65068	Longlife+
6	SC66068	Longlife+

### Electroplated Kit ●

CODE	TECHNOLOGY
SC67192	Electroplated
SC68192	Electroplated
SC63192	BiPower
SC64192	Longlife+
SC65192	Longlife+
SC66192	Longlife+

### Electroplated Kit ●

CODE	TECHNOLOGY
SC67070	Electroplated
SC68070	Electroplated
SC63070	BiPower
SC64070	Longlife+
SC65070	Longlife+
SC66070	Longlife+



## O30

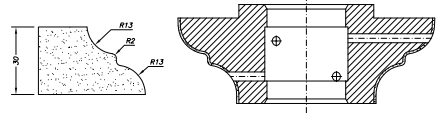

## O40

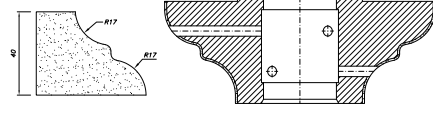

## OG20

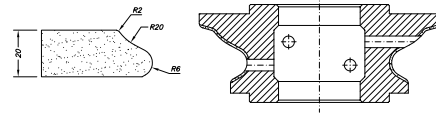

## OG30

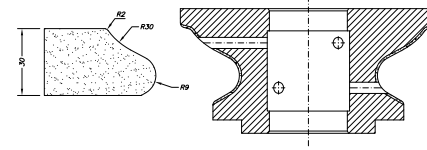

## Q20

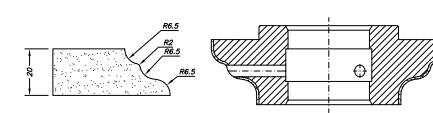

## Q30

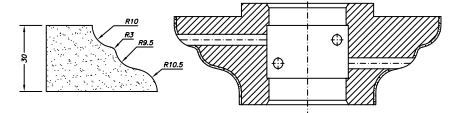

### EHS Kit ▲ ■ ●

POS.	CODE	TECHNOLOGY
00	SC72071	Frangistone
0	SCR72071	Razorstone
1	SCE61071	EHS
2	SCE62071	EHS
3	SCE63071	EHS
4	SC64071	Longlife+
5	SC65071	Longlife+
6	SC66071	Longlife+

### EHS Kit ▲ ■ ●

POS.	CODE	TECHNOLOGY
00	SC72072	Frangistone
0	SCR72072	Razorstone
1	SCE61072	EHS
2	SCE62072	EHS
3	SCE63072	EHS
4	SC64072	Longlife+
5	SC65072	Longlife+
6	SC66072	Longlife+

### EHS Kit ▲ ■ ●

POS.	CODE	TECHNOLOGY
00	SC72153	Frangistone
0	SCR72153	Razorstone
1	SCE61153	EHS
2	SCE62153	EHS
3	SCE63153	EHS
4	SC64153	Longlife+
5	SC65153	Longlife+
6	SC66153	Longlife+

### EHS Kit ▲ ■ ●

POS.	CODE	TECHNOLOGY
00	SC72154	Frangistone
0	SCR72154	Razorstone
1	SCE61154	EHS
2	SCE62154	EHS
3	SCE63154	EHS
4	SC64154	Longlife+
5	SC65154	Longlife+
6	SC66154	Longlife+

### EHS Kit ▲ ■ ●

POS.	CODE	TECHNOLOGY
00	SC72077	Frangistone
0	SCR72077	Razorstone
1	SCE61077	EHS
2	SCE62077	EHS
3	SCE63077	EHS
4	SC64077	Longlife+
5	SC65077	Longlife+
6	SC66077	Longlife+

### EHS Kit ▲ ■ ●

POS.	CODE	TECHNOLOGY
00	SC72078	Frangistone
0	SCR72078	Razorstone
1	SCE61078	EHS
2	SCE62078	EHS
3	SCE63078	EHS
4	SC64078	Longlife+
5	SC65078	Longlife+
6	SC66078	Longlife+

### Standard Kit ▲ ■ ●

POS.	CODE	TECHNOLOGY
00	SC72071	Frangistone
0	SCR72071	Razorstone
1	SC61071	Zenith
2	SC62071	Zenith
3	SC63071	BiPower
3X	SC6X071	XtraFine
4	SC64071	Longlife+
5	SC65071	Longlife+
6	SC66071	Longlife+

### Standard Kit ▲ ■ ●

POS.	CODE	TECHNOLOGY
00	SC72072	Frangistone
0	SCR72072	Razorstone
1	SC61072	Zenith
2	SC62072	Zenith
3	SC63072	BiPower
3X	SC6X072	XtraFine
4	SC64072	Longlife+
5	SC65072	Longlife+
6	SC66072	Longlife+

### Standard Kit ▲ ■ ●

POS.	CODE	TECHNOLOGY
00	SC72153	Frangistone
0	SCR72153	Razorstone
1	SC61153	Zenith
2	SC62153	Zenith
3	SC63153	BiPower
3X	SC6X153	XtraFine
4	SC64153	Longlife+
5	SC65153	Longlife+
6	SC66153	Longlife+

### Standard Kit ▲ ■ ●

POS.	CODE	TECHNOLOGY
00	SC72154	Frangistone
0	SCR72154	Razorstone
1	SC61154	Zenith
2	SC62154	Zenith
3	SC63154	BiPower
3X	SC6X154	XtraFine
4	SC64154	Longlife+
5	SC65154	Longlife+
6	SC66154	Longlife+

### Standard Kit ▲ ■ ●

POS.	CODE	TECHNOLOGY
00	SC72077	Frangistone
0	SCR72077	Razorstone
1	SC61077	Zenith
2	SC62077	Zenith
3	SC63077	BiPower
3X	SC6X077	XtraFine
4	SC64077	Longlife+
5	SC65077	Longlife+
6	SC66077	Longlife+

### Standard Kit ▲ ■ ●

POS.	CODE	TECHNOLOGY
00	SC72078	Frangistone
0	SCR72078	Razorstone
1	SC61078	Zenith
2	SC62078	Zenith
3	SC63078	BiPower
3X	SC6X078	XtraFine
4	SC64078	Longlife+
5	SC65078	Longlife+
6	SC66078	Longlife+

### Electroplated Kit ●

POS.	CODE	TECHNOLOGY
1	SC67071	Electroplated
2	SC68071	Electroplated
3	SC63071	BiPower
4	SC64071	Longlife+
5	SC65071	Longlife+
6	SC66071	Longlife+

### Electroplated Kit ●

POS.	CODE	TECHNOLOGY
1	SC67072	Electroplated
2	SC68072	Electroplated
3	SC63072	BiPower
4	SC64072	Longlife+
5	SC65072	Longlife+
6	SC66072	Longlife+

### Electroplated Kit ●

POS.	CODE	TECHNOLOGY
1	SC67153	Electroplated
2	SC68153	Electroplated
3	SC63153	BiPower
4	SC64153	Longlife+
5	SC65153	Longlife+
6	SC66153	Longlife+

### Electroplated Kit ●

POS.	CODE	TECHNOLOGY
1	SC67154	Electroplated
2	SC68154	Electroplated
3	SC63154	BiPower
4	SC64154	Longlife+
5	SC65154	Longlife+
6	SC66154	Longlife+

### Electroplated Kit ●

POS.	CODE	TECHNOLOGY
1	SC67077	Electroplated
2	SC68077	Electroplated
3	SC63077	BiPower
4	SC64077	Longlife+
5	SC65077	Longlife+
6	SC66077	Longlife+

### Electroplated Kit ●

POS.	CODE	TECHNOLOGY
1	SC67078	Electroplated
2	SC68078	Electroplated
3	SC63078	BiPower
4	SC64078	Longlife+
5	SC65078	Longlife+
6	SC66078	Longlife+





## Q40

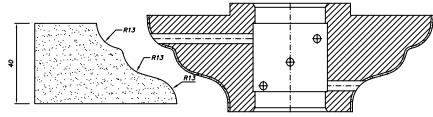

## T12 r2.5

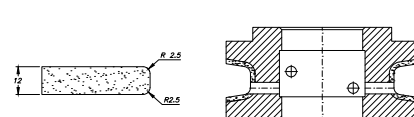

## T12 r5

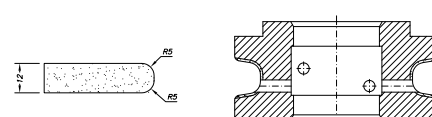

## T20 r3

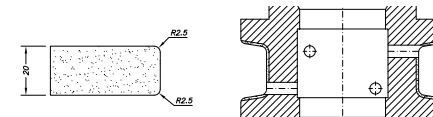

## T20 r5

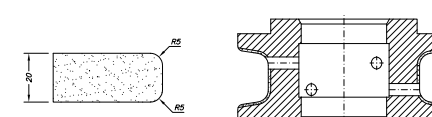

## T30 r3

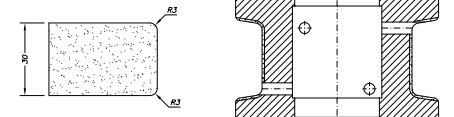

### EHS Kit ▲ ■ ●

POS.	CODE	TECHNOLOGY
00	SC72079	Frangistone
0	SCR72079	Razorstone
1	SCE61079	EHS
2	SCE62079	EHS
3	SCE63079	EHS
4	SC64079	Longlife+
5	SC65079	Longlife+
6	SC66079	Longlife+

### EHS Kit ▲ ■ ●

CODE	TECHNOLOGY
-	-
SCE61D168	EHS
SCE62D168	EHS
SCE63D168	EHS
SC64D168	Longlife+
SC65D168	Longlife+
SC66D168	Longlife+

### EHS Kit ▲ ■ ●

CODE	TECHNOLOGY
-	-
SCE61243	EHS
SCE62243	EHS
SCE63243	EHS
SC64243	Longlife+
SC65243	Longlife+
SC66243	Longlife+

### EHS Kit ▲ ■ ●

POS.	CODE	TECHNOLOGY
1	SCE61114	EHS
2	SCE62114	EHS
3	SCE63114	EHS
4	SC64114	Longlife+
5	SC65114	Longlife+
6	SC66114	Longlife+

### EHS Kit ▲ ■ ●

CODE	TECHNOLOGY
SCE61080	EHS
SCE62080	EHS
SCE63080	EHS
SC64080	Longlife+
SC65080	Longlife+
SC66080	Longlife+

### EHS Kit ▲ ■ ●

CODE	TECHNOLOGY
SCE61115	EHS
SCE62115	EHS
SCE63115	EHS
SC64115	Longlife+
SC65115	Longlife+
SC66115	Longlife+

### Standard Kit ▲ ■ ●

POS.	CODE	TECHNOLOGY
00	SC72079	Frangistone
0	SCR72079	Razorstone
1	SC61079	Zenith
2	SC62079	Zenith
3	SC63079	BiPower
3X	SC6X079	XtraFine
4	SC64079	Longlife+
5	SC65079	Longlife+
6	SC66079	Longlife+

### Standard Kit ▲ ■ ●

CODE	TECHNOLOGY
-	-
SC61D168	Zenith
SC62D168	Zenith
SC63D168	BiPower
SC6XD168	XtraFine
SC64D168	Longlife+
SC65D168	Longlife+
SC66D168	Longlife+

### Standard Kit ▲ ■ ●

CODE	TECHNOLOGY
-	-
SC61243	Zenith
SC62243	Zenith
SC63243	BiPower
SC6X243	XtraFine
SC64243	Longlife+
SC65243	Longlife+
SC66243	Longlife+

### Standard Kit ▲ ■ ●

POS.	CODE	TECHNOLOGY
1	SC61114	Zenith
2	SC62114	Zenith
3	SC63114	BiPower
3X	SC6X114	XtraFine
4	SC64114	Longlife+
5	SC65114	Longlife+
6	SC66114	Longlife+

### Standard Kit ▲ ■ ●

CODE	TECHNOLOGY
SC61080	Zenith
SC62080	Zenith
SC63080	BiPower
SC6X080	XtraFine
SC64080	Longlife+
SC65080	Longlife+
SC66080	Longlife+

### Standard Kit ▲ ■ ●

CODE	TECHNOLOGY
SC61115	Zenith
SC62115	Zenith
SC63115	BiPower
SC6X115	XtraFine
SC64115	Longlife+
SC65115	Longlife+
SC66115	Longlife+

### Electroplated Kit ●

POS.	CODE	TECHNOLOGY
1	SC67079	Electroplated
2	SC68079	Electroplated
3	SC63079	BiPower
4	SC64079	Longlife+
5	SC65079	Longlife+
6	SC66079	Longlife+

### Electroplated Kit ●

CODE	TECHNOLOGY
SC67D168	Electroplated
SC68D168	Electroplated
SC63D168	BiPower
SC64D168	Longlife+
SC65D168	Longlife+
SC66D168	Longlife+

### Electroplated Kit ●

CODE	TECHNOLOGY
SC67243	Electroplated
SC68243	Electroplated
SC63243	BiPower
SC64243	Longlife+
SC65243	Longlife+
SC66243	Longlife+

### Electroplated Kit ●

POS.	CODE	TECHNOLOGY
1	SC67114	Electroplated
2	SC68114	Electroplated
3	SC63114	BiPower
4	SC64114	Longlife+
5	SC65114	Longlife+
6	SC66114	Longlife+

### Electroplated Kit ●

CODE	TECHNOLOGY
SC67080	Electroplated
SC68080	Electroplated
SC63080	BiPower
SC64080	Longlife+
SC65080	Longlife+
SC66080	Longlife+

### Electroplated Kit ●

CODE	TECHNOLOGY
SC67115	Electroplated
SC68115	Electroplated
SC63115	BiPower
SC64115	Longlife+
SC65115	Longlife+
SC66115	Longlife+

POS.
4
5
6

### Glossforce3.0 ▲ ■ ●

CODE	TECHNOLOGY
SCG64115	GlossForce 3.0
SCG65115	GlossForce 3.0
SCG66115	GlossForce 3.0



## T30 r3 30°

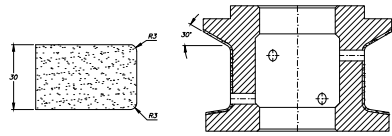

## T30 r4

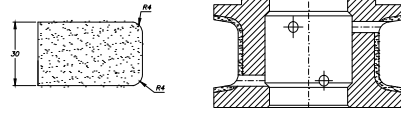

## T30 r5

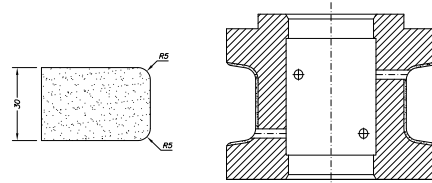

## T30 r6

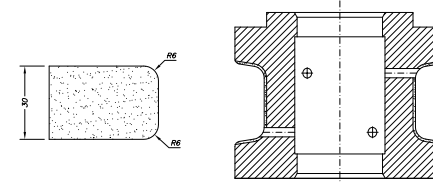

## T30 r8

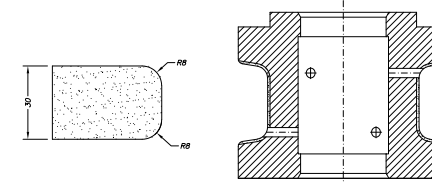

## T30 r10

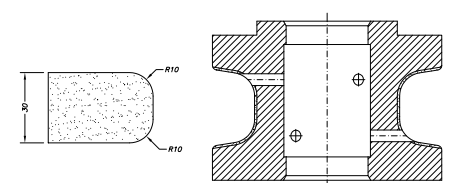

### EHS Kit ▲ ■ ●

POS.	CODE	TECHNOLOGY
1	SCE61D422	EHS
2	SCE62D422	EHS
3	SCE63D422	EHS
4	SC64D422	Longlife+
5	SC65D422	Longlife+
6	SC66D422	Longlife+

### EHS Kit ▲ ■ ●

CODE	TECHNOLOGY
SCE61444	EHS
SCE62444	EHS
SCE63444	EHS
SC64444	Longlife+
SC65444	Longlife+
SC66444	Longlife+

### EHS Kit ▲ ■ ●

CODE	TECHNOLOGY
SCE61082	EHS
SCE62082	EHS
SCE63082	EHS
SC64082	Longlife+
SC65082	Longlife+
SC66082	Longlife+

### EHS Kit ▲ ■ ●

POS.	CODE	TECHNOLOGY
00	-	-
0	-	-
1	SCE61D156	EHS
2	SCE62D156	EHS
3	SCE63D156	EHS
4	SC64D156	Longlife+
5	SC65D156	Longlife+
6	SC66D156	Longlife+

### EHS Kit ▲ ■ ●

CODE	TECHNOLOGY
-	-
-	-
SCE61D096	EHS
SCE62D096	EHS
SCE63D096	EHS
SC64D096	Longlife+
SC65D096	Longlife+
SC66D096	Longlife+

### EHS Kit ▲ ■ ●

CODE	TECHNOLOGY
SC72081	Frangistone
SCR72081	Razorstone
SCE61081	EHS
SCE62081	EHS
SCE63081	EHS
SC64081	Longlife+
SC65081	Longlife+
SC66081	Longlife+

### Standard Kit ▲ ■ ●

POS.	CODE	TECHNOLOGY
1	SC61D422	Zenith
2	SC62D422	Zenith
3	SC63D422	BiPower
3X	SC6XD422	XtraFine
4	SC64D422	Longlife+
5	SC65D422	Longlife+
6	SC66D422	Longlife+

### Standard Kit ▲ ■ ●

CODE	TECHNOLOGY
SC61444	Zenith
SC62444	Zenith
SC63444	BiPower
SC6444X	XtraFine
SC64444	Longlife+
SC65444	Longlife+
SC66444	Longlife+

### Standard Kit ▲ ■ ●

CODE	TECHNOLOGY
SC61082	Zenith
SC62082	Zenith
SC63082	BiPower
SC6X082	XtraFine
SC64082	Longlife+
SC65082	Longlife+
SC66082	Longlife+

### Standard Kit ▲ ■ ●

POS.	CODE	TECHNOLOGY
00	-	-
0	-	-
1	SC61D156	Zenith
2	SC62D156	Zenith
3	SC63D156	BiPower
3X	SC6XD156	XtraFine
4	SC64D156	Longlife+
5	SC65D156	Longlife+
6	SC66D156	Longlife+

### Standard Kit ▲ ■ ●

CODE	TECHNOLOGY
-	-
-	-
SC61D096	Zenith
SC62D096	Zenith
SC63D096	BiPower
SC6XD096	XtraFine
SC64D096	Longlife+
SC65D096	Longlife+
SC66D096	Longlife+

### Standard Kit ▲ ■ ●

CODE	TECHNOLOGY
SC72081	Frangistone
SCR72081	Razorstone
SC61081	Zenith
SC62081	Zenith
SC63081	BiPower
SC6X081	XtraFine
SC64081	Longlife+
SC65081	Longlife+
SC66081	Longlife+

### Electroplated Kit ●

POS.	CODE	TECHNOLOGY
1	SC67D422	Electroplated
2	SC68D422	Electroplated
3	SC63D422	BiPower
4	SC64D422	Longlife+
5	SC65D422	Longlife+
6	SC66D422	Longlife+

### Electroplated Kit ●

CODE	TECHNOLOGY
SC67444	Electroplated
SC68444	Electroplated
SC63444	BiPower
SC64444	Longlife+
SC65444	Longlife+
SC66444	Longlife+

### Electroplated Kit ●

CODE	TECHNOLOGY
SC67082	Electroplated
SC68082	Electroplated
SC63082	BiPower
SC64082	Longlife+
SC65082	Longlife+
SC66082	Longlife+

### Electroplated Kit ●

POS.	CODE	TECHNOLOGY
1	SC67D156	Electroplated
2	SC68D156	Electroplated
3	SC63D156	BiPower
4	SC64D156	Longlife+
5	SC65D156	Longlife+
6	SC66D156	Longlife+

### Electroplated Kit ●

CODE	TECHNOLOGY
SC67D096	Electroplated
SC68D096	Electroplated
SC63D096	BiPower
SC64D096	Longlife+
SC65D096	Longlife+
SC66D096	Longlife+

### Electroplated Kit ●

CODE	TECHNOLOGY
SC67081	Electroplated
SC68081	Electroplated
SC63081	BiPower
SC64081	Longlife+
SC65081	Longlife+
SC66081	Longlife+

### Glossforce3.0

POS.
4
5
6

CODE	TECHNOLOGY
SCG64D096	GlossForce 3.0
SCG65D096	GlossForce 3.0
SCG66D096	GlossForce 3.0





## T40 r3.5

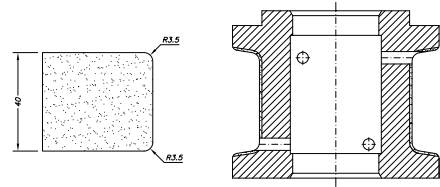

## T40 r5

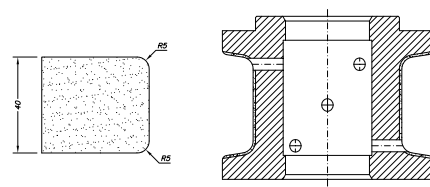

## TP20

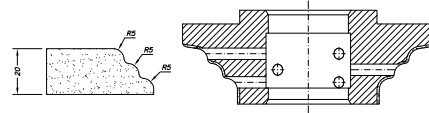

## TP30

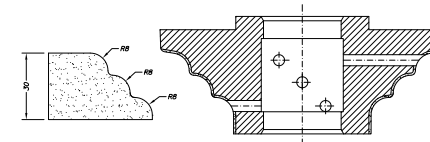

## TP30 Pfd DEC

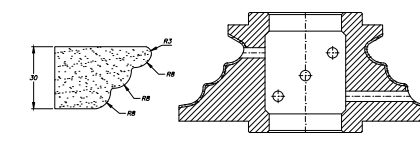

## V12

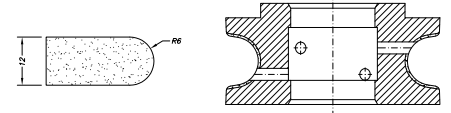

### EHS Kit ▲ ■ ●

POS.	CODE	TECHNOLOGY
00	-	-
0	-	-
1	SCE61117	EHS
2	SCE62117	EHS
3	SCE63117	EHS
4	SC64117	Longlife+
5	SC65117	Longlife+
6	SC66117	Longlife+

### EHS Kit ▲ ■ ●

POS.	CODE	TECHNOLOGY
00	-	-
0	-	-
1	SCE61084	EHS
2	SCE62084	EHS
3	SCE63084	EHS
4	SC64084	Longlife+
5	SC65084	Longlife+
6	SC66084	Longlife+

### EHS Kit ▲ ■ ●

POS.	CODE	TECHNOLOGY
00	SC72029	Frangistone
0	SCR72029	Razorstone
1	SCE61029	EHS
2	SCE62029	EHS
3	SCE63029	EHS
4	SC64029	Longlife+
5	SC65029	Longlife+
6	SC66029	Longlife+

### EHS Kit ▲ ■ ●

POS.	CODE	TECHNOLOGY
00	SC72030	Frangistone
0	SCR72030	Razorstone
1	SCE61030	EHS
2	SCE62030	EHS
3	SCE63030	EHS
4	SC64030	Longlife+
5	SC65030	Longlife+
6	SC66030	Longlife+

### EHS Kit ▲ ■ ●

POS.	CODE	TECHNOLOGY
00	SC72189	Frangistone
0	SCR72189	Razorstone
1	SCE61189	EHS
2	SCE62189	EHS
3	SCE63189	EHS
4	SC64189	Longlife+
5	SC65189	Longlife+
6	SC66189	Longlife+

### EHS Kit ▲ ■ ●

POS.	CODE	TECHNOLOGY
00	-	-
0	-	-
1	SCE61265	EHS
2	SCE62265	EHS
3	SCE63265	EHS
4	SC64265	Longlife+
5	SC65265	Longlife+
6	SC66265	Longlife+

### Standard Kit ▲ ■ ●

POS.	CODE	TECHNOLOGY
00	-	-
0	-	-
1	SC61117	Zenith
2	SC62117	Zenith
3	SC63117	BiPower
3X	SC6X117	XtraFine
4	SC64117	Longlife+
5	SC65117	Longlife+
6	SC66117	Longlife+

### Standard Kit ▲ ■ ●

POS.	CODE	TECHNOLOGY
00	-	-
0	-	-
1	SC61084	Zenith
2	SC62084	Zenith
3	SC63084	BiPower
3X	SC6X084	XtraFine
4	SC64084	Longlife+
5	SC65084	Longlife+
6	SC66084	Longlife+

### Standard Kit ▲ ■ ●

POS.	CODE	TECHNOLOGY
00	SC72029	Frangistone
0	SCR72029	Razorstone
1	SC61029	Zenith
2	SC62029	Zenith
3	SC63029	BiPower
3X	SC6X029	XtraFine
4	SC64029	Longlife+
5	SC65029	Longlife+
6	SC66029	Longlife+

### Standard Kit ▲ ■ ●

POS.	CODE	TECHNOLOGY
00	SC72030	Frangistone
0	SCR72030	Razorstone
1	SC61030	Zenith
2	SC62030	Zenith
3	SC63030	BiPower
3X	SC6X030	XtraFine
4	SC64030	Longlife+
5	SC65030	Longlife+
6	SC66030	Longlife+

### Standard Kit ▲ ■ ●

POS.	CODE	TECHNOLOGY
00	SC72189	Frangistone
0	SCR72189	Razorstone
1	SC61189	Zenith
2	SC62189	Zenith
3	SC63189	BiPower
3X	SC6X189	XtraFine
4	SC64189	Longlife+
5	SC65189	Longlife+
6	SC66189	Longlife+

### Standard Kit ▲ ■ ●

POS.	CODE	TECHNOLOGY
00	-	-
0	-	-
1	SC61265	Zenith
2	SC62265	Zenith
3	SC63265	BiPower
3X	SC6X265	XtraFine
4	SC64265	Longlife+
5	SC65265	Longlife+
6	SC66265	Longlife+

### Electroplated Kit ●

POS.	CODE	TECHNOLOGY
1	SC67117	Electroplated
2	SC68117	Electroplated
3	SC63117	BiPower
4	SC64117	Longlife+
5	SC65117	Longlife+
6	SC66117	Longlife+

### Electroplated Kit ●

POS.	CODE	TECHNOLOGY
1	SC67084	Electroplated
2	SC68084	Electroplated
3	SC63084	BiPower
4	SC64084	Longlife+
5	SC65084	Longlife+
6	SC66084	Longlife+

### Electroplated Kit ●

POS.	CODE	TECHNOLOGY
1	SC67029	Electroplated
2	SC68029	Electroplated
3	SC63029	BiPower
4	SC64029	Longlife+
5	SC65029	Longlife+
6	SC66029	Longlife+

### Electroplated Kit ●

POS.	CODE	TECHNOLOGY
1	SC67030	Electroplated
2	SC68030	Electroplated
3	SC63030	BiPower
4	SC64030	Longlife+
5	SC65030	Longlife+
6	SC66030	Longlife+

### Electroplated Kit ●

POS.	CODE	TECHNOLOGY
1	SC67189	Electroplated
2	SC68189	Electroplated
3	SC63189	BiPower
4	SC64189	Longlife+
5	SC65189	Longlife+
6	SC66189	Longlife+

### Electroplated Kit ●

POS.	CODE	TECHNOLOGY
1	SC67265	Electroplated
2	SC68265	Electroplated
3	SC63265	BiPower
4	SC64265	Longlife+
5	SC65265	Longlife+
6	SC66265	Longlife+



## V20

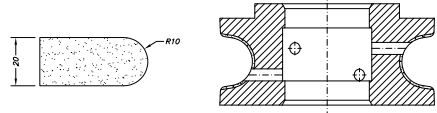

## V30

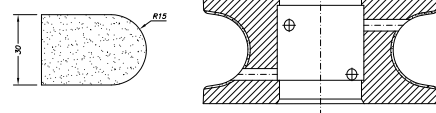

## V40

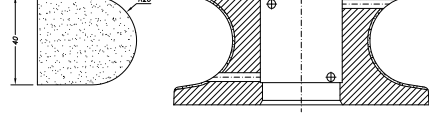

## V50

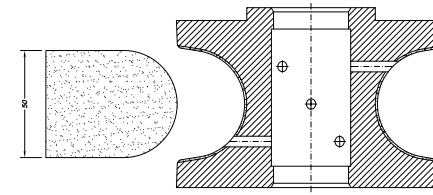

## V60

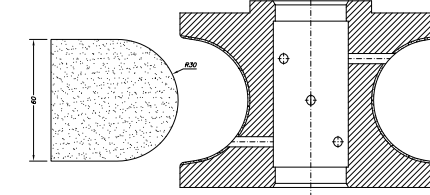

## V+Q30

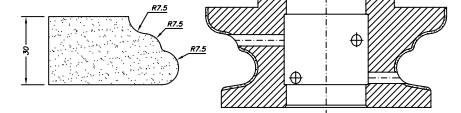

### EHS Kit ▲ ■ ●

POS.	CODE	TECHNOLOGY
00	SC72087	Frangistone
0	SCR72087	Razorstone
1	SCE61087	EHS
2	SCE62087	EHS
3	SCE63087	EHS
4	SC64087	Longlife+
5	SC65087	Longlife+
6	SC66087	Longlife+

### EHS Kit ▲ ■ ●

POS.	CODE	TECHNOLOGY
00	SC72088	Frangistone
0	SCR72088	Razorstone
1	SCE61088	EHS
2	SCE62088	EHS
3	SCE63088	EHS
4	SC64088	Longlife+
5	SC65088	Longlife+
6	SC66088	Longlife+

### EHS Kit ▲ ■ ●

POS.	CODE	TECHNOLOGY
00	SC72090	Frangistone
0	SCR72090	Razorstone
1	SCE61090	EHS
2	SCE62090	EHS
3	SCE63090	EHS
4	SC64090	Longlife+
5	SC65090	Longlife+
6	SC66090	Longlife+

### EHS Kit ▲ ■ ●

POS.	CODE	TECHNOLOGY
00	SC72092	Frangistone
0	SCR72092	Razorstone
1	SCE61092	EHS
2	SCE62092	EHS
3	SCE63092	EHS
4	SC64092	Longlife+
5	SC65092	Longlife+
6	SC66092	Longlife+

### EHS Kit ▲ ■ ●

POS.	CODE	TECHNOLOGY
00	SC72093	Frangistone
0	SCR72093	Razorstone
1	SCE61093	EHS
2	SCE62093	EHS
3	SCE63093	EHS
4	SC64093	Longlife+
5	SC65093	Longlife+
6	SC66093	Longlife+

### EHS Kit ▲ ■ ●

POS.	CODE	TECHNOLOGY
00	SC72103	Frangistone
0	SCR72103	Razorstone
1	SCE61103	EHS
2	SCE62103	EHS
3	SCE63103	EHS
4	SC64103	Longlife+
5	SC65103	Longlife+
6	SC66103	Longlife+

### Standard Kit ▲ ■ ●

POS.	CODE	TECHNOLOGY
00	SC72087	Frangistone
0	SCR72087	Razorstone
1	SC61087	Zenith
2	SC62087	Zenith
3	SC63087	BiPower
3X	SC6X087	XtraFine
4	SC64087	Longlife+
5	SC65087	Longlife+
6	SC66087	Longlife+

### Standard Kit ▲ ■ ●

POS.	CODE	TECHNOLOGY
00	SC72088	Frangistone
0	SCR72088	Razorstone
1	SC61088	Zenith
2	SC62088	Zenith
3	SC63088	BiPower
3X	SC6X088	XtraFine
4	SC64088	Longlife+
5	SC65088	Longlife+
6	SC66088	Longlife+

### Standard Kit ▲ ■ ●

POS.	CODE	TECHNOLOGY
00	SC72090	Frangistone
0	SCR72090	Razorstone
1	SC61090	Zenith
2	SC62090	Zenith
3	SC63090	BiPower
3X	SC6X090	XtraFine
4	SC64090	Longlife+
5	SC65090	Longlife+
6	SC66090	Longlife+

### Standard Kit ▲ ■ ●

POS.	CODE	TECHNOLOGY
00	SC72092	Frangistone
0	SCR72092	Razorstone
1	SC61092	Zenith
2	SC62092	Zenith
3	SC63092	BiPower
3X	SC6X092	XtraFine
4	SC64092	Longlife+
5	SC65092	Longlife+
6	SC66092	Longlife+

### Standard Kit ▲ ■ ●

POS.	CODE	TECHNOLOGY
00	SC72093	Frangistone
0	SCR72093	Razorstone
1	SC61093	Zenith
2	SC62093	Zenith
3	SC63093	BiPower
3X	SC6X093	XtraFine
4	SC64093	Longlife+
5	SC65093	Longlife+
6	SC66093	Longlife+

### Standard Kit ▲ ■ ●

POS.	CODE	TECHNOLOGY
00	SC72103	Frangistone
0	SCR72103	Razorstone
1	SC61103	Zenith
2	SC62103	Zenith
3	SC63103	BiPower
3X	SC6X103	XtraFine
4	SC64103	Longlife+
5	SC65103	Longlife+
6	SC66103	Longlife+

### Electroplated Kit ●

POS.	CODE	TECHNOLOGY
1	SC67087	Electroplated
2	SC68087	Electroplated
3	SC63087	BiPower
4	SC64087	Longlife+
5	SC65087	Longlife+
6	SC66087	Longlife+

### Electroplated Kit ●

POS.	CODE	TECHNOLOGY
1	SC67088	Electroplated
2	SC68088	Electroplated
3	SC63088	BiPower
4	SC64088	Longlife+
5	SC65088	Longlife+
6	SC66088	Longlife+

### Electroplated Kit ●

POS.	CODE	TECHNOLOGY
1	SC67090	Electroplated
2	SC68090	Electroplated
3	SC63090	BiPower
4	SC64090	Longlife+
5	SC65090	Longlife+
6	SC66090	Longlife+

### Electroplated Kit ●

POS.	CODE	TECHNOLOGY
1	SC67092	Electroplated
2	SC68092	Electroplated
3	SC63092	BiPower
4	SC64092	Longlife+
5	SC65092	Longlife+
6	SC66092	Longlife+

### Electroplated Kit ●

POS.	CODE	TECHNOLOGY
1	SC67093	Electroplated
2	SC68093	Electroplated
3	SC63093	BiPower
4	SC64093	Longlife+
5	SC65093	Longlife+
6	SC66093	Longlife+

### Electroplated Kit ●

POS.	CODE	TECHNOLOGY
1	SC67103	Electroplated
2	SC68103	Electroplated
3	SC63103	BiPower
4	SC64103	Longlife+
5	SC65103	Longlife+
6	SC66103	Longlife+



## V+Q40

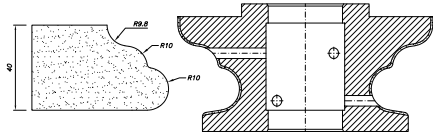

## X+D12

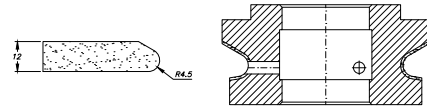

## X+D20

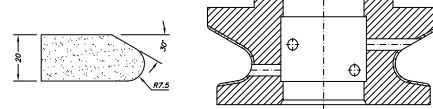

## X+D30

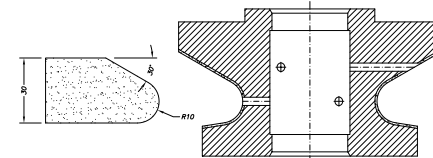

## X+D40

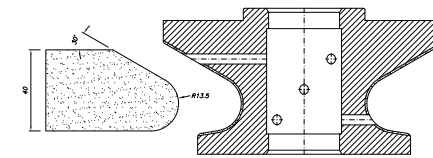

## YS12 1.5x1.5

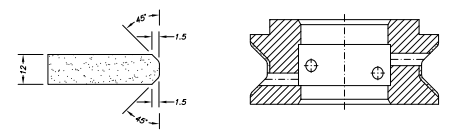

### EHS Kit ▲ ■ ●

POS.	CODE	TECHNOLOGY
00	SC72104	Frangistone
0	SCR72104	Razorstone
1	SCE61104	EHS
2	SCE62104	EHS
3	SCE63104	EHS
4	SC64104	Longlife+
5	SC65104	Longlife+
6	SC66104	Longlife+

### EHS Kit ▲ ■ ●

POS.	CODE	TECHNOLOGY
00	-	-
0	-	-
1	SCE61110	EHS
2	SCE62110	EHS
3	SCE63110	EHS
4	SC64110	Longlife+
5	SC65110	Longlife+
6	SC66110	Longlife+

### EHS Kit ▲ ■ ●

POS.	CODE	TECHNOLOGY
00	SC72108	Frangistone
0	SCR72108	Razorstone
1	SCE61108	EHS
2	SCE62108	EHS
3	SCE63108	EHS
4	SC64108	Longlife+
5	SC65108	Longlife+
6	SC66108	Longlife+

### EHS Kit ▲ ■ ●

POS.	CODE	TECHNOLOGY
00	SC72109	Frangistone
0	SCR72109	Razorstone
1	SCE61109	EHS
2	SCE62109	EHS
3	SCE63109	EHS
4	SC64109	Longlife+
5	SC65109	Longlife+
6	SC66109	Longlife+

### EHS Kit ▲ ■ ●

POS.	CODE	TECHNOLOGY
00	SC72111	Frangistone
0	SCR72111	Razorstone
1	SCE61111	EHS
2	SCE62111	EHS
3	SCE63111	EHS
4	SC64111	Longlife+
5	SC65111	Longlife+
6	SC66111	Longlife+

### EHS Kit ▲ ■ ●

POS.	CODE	TECHNOLOGY
00	-	-
0	-	-
1	SCE61D191	EHS
2	SCE62D191	EHS
3	SCE63D191	EHS
4	SC65D191	Longlife+
5	SC65D191	Longlife+
6	SC66D191	Longlife+

### Standard Kit ▲ ■ ●

POS.	CODE	TECHNOLOGY
00	SC72104	Frangistone
0	SCR72104	Razorstone
1	SC61104	Zenith
2	SC62104	Zenith
3	SC63104	BiPower
3X	SC6X104	XtraFine
4	SC64104	Longlife+
5	SC65104	Longlife+
6	SC66104	Longlife+

### Standard Kit ▲ ■ ●

POS.	CODE	TECHNOLOGY
00	-	-
0	-	-
1	SC61110	Zenith
2	SC62110	Zenith
3	SC63110	BiPower
3X	SC6X110	XtraFine
4	SC64110	Longlife+
5	SC65110	Longlife+
6	SC66110	Longlife+

### Standard Kit ▲ ■ ●

POS.	CODE	TECHNOLOGY
00	SC72108	Frangistone
0	SCR72108	Razorstone
1	SC61108	Zenith
2	SC62108	Zenith
3	SC63108	BiPower
3X	SC6X108	XtraFine
4	SC64108	Longlife+
5	SC65108	Longlife+
6	SC66108	Longlife+

### Standard Kit ▲ ■ ●

POS.	CODE	TECHNOLOGY
00	SC72109	Frangistone
0	SCR72109	Razorstone
1	SC61109	Zenith
2	SC62109	Zenith
3	SC63109	BiPower
3X	SC6X109	XtraFine
4	SC64109	Longlife+
5	SC65109	Longlife+
6	SC66109	Longlife+

### Standard Kit ▲ ■ ●

POS.	CODE	TECHNOLOGY
00	SC72111	Frangistone
0	SCR72111	Razorstone
1	SC61111	Zenith
2	SC62111	Zenith
3	SC63111	BiPower
3X	SC6X111	XtraFine
4	SC64111	Longlife+
5	SC65111	Longlife+
6	SC66111	Longlife+

### Standard Kit ▲ ■ ●

POS.	CODE	TECHNOLOGY
00	-	-
0	-	-
1	SC61D191	Zenith
2	SC62D191	Zenith
3	SC63D191	BiPower
3X	SC6XD191	XtraFine
4	SC65D191	Longlife+
5	SC65D191	Longlife+
6	SC66D191	Longlife+

### Electroplated Kit ●

POS.	CODE	TECHNOLOGY
1	SC67104	Electroplated
2	SC68104	Electroplated
3	SC63104	BiPower
4	SC64104	Longlife+
5	SC65104	Longlife+
6	SC66104	Longlife+

### Electroplated Kit ●

POS.	CODE	TECHNOLOGY
1	SC67110	Electroplated
2	SC68110	Electroplated
3	SC63110	BiPower
4	SC64110	Longlife+
5	SC65110	Longlife+
6	SC66110	Longlife+

### Electroplated Kit ●

POS.	CODE	TECHNOLOGY
1	SC67108	Electroplated
2	SC68108	Electroplated
3	SC63108	BiPower
4	SC64108	Longlife+
5	SC65108	Longlife+
6	SC66108	Longlife+

### Electroplated Kit ●

POS.	CODE	TECHNOLOGY
1	SC67109	Electroplated
2	SC68109	Electroplated
3	SC63109	BiPower
4	SC64109	Longlife+
5	SC65109	Longlife+
6	SC66109	Longlife+

### Electroplated Kit ●

POS.	CODE	TECHNOLOGY
1	SC67111	Electroplated
2	SC68111	Electroplated
3	SC63111	BiPower
4	SC64111	Longlife+
5	SC65111	Longlife+
6	SC66111	Longlife+

### Electroplated Kit ●

POS.	CODE	TECHNOLOGY
1	SC67D191	Electroplated
2	SC68D191	Electroplated
3	SC63D191	BiPower
4	SC65D191	Longlife+
5	SC65D191	Longlife+
6	SC66D191	Longlife+



## YS20 1.5x1.5

## YS20 2x2

## YS20 3x3

## YS30 1.5x1.5

## YS30 2x2

## YS30 3x3

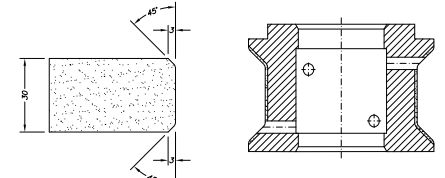
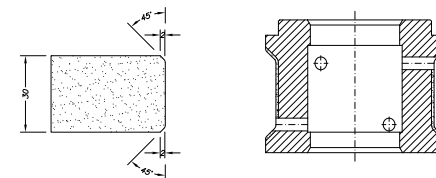
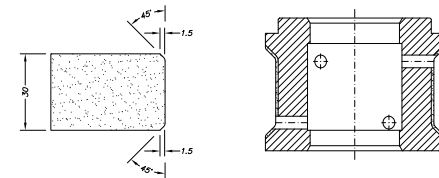
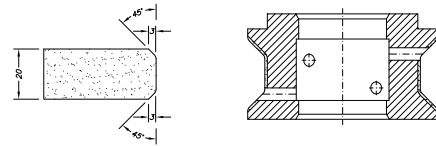
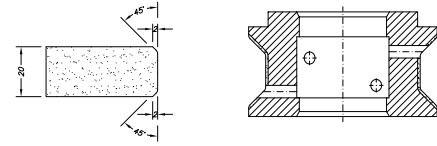
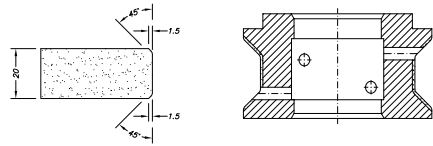

### EHS Kit ▲ ■ ●

### EHS Kit ▲ ■ ●

### EHS Kit ▲ ■ ●

### EHS Kit ▲ ■ ●

### EHS Kit ▲ ■ ●

### EHS Kit ▲ ■ ●

POS.	CODE	TECHNOLOGY
1	SCE61D028	EHS
2	SCE62D028	EHS
3	SCE63D028	EHS
4	SC64D028	Longlife+
5	SC65D028	Longlife+
6	SC66D028	Longlife+

CODE	TECHNOLOGY
SCE61D283	EHS
SCE62D283	EHS
SCE63D283	EHS
SC64D283	Longlife+
SC65D283	Longlife+
SC66D283	Longlife+

CODE	TECHNOLOGY
SCE61I20	EHS
SCE62I20	EHS
SCE63I20	EHS
SC64I20	Longlife+
SC65I20	Longlife+
SC66I20	Longlife+

POS.	CODE	TECHNOLOGY
1	SCE61D445	EHS
2	SCE62D445	EHS
3	SCE63D445	EHS
4	SC64D445	Longlife+
5	SC65D445	Longlife+
6	SC66D445	Longlife+

CODE	TECHNOLOGY
SCE61I22	EHS
SCE62I22	EHS
SCE63I22	EHS
SC64I22	Longlife+
SC65I22	Longlife+
SC66I22	Longlife+

CODE	TECHNOLOGY
SCE61I21	EHS
SCE62I21	EHS
SCE63I21	EHS
SC64I21	Longlife+
SC65I21	Longlife+
SC66I21	Longlife+

### Standard Kit ▲ ■ ●

### Standard Kit ▲ ■ ●

### Standard Kit ▲ ■ ●

### Standard Kit ▲ ■ ●

### Standard Kit ▲ ■ ●

### Standard Kit ▲ ■ ●

POS.	CODE	TECHNOLOGY
1	SC61D028	Zenith
2	SC62D028	Zenith
3	SC63D028	BiPower
3X	SC6XD028	XtraFine
4	SC64D028	Longlife+
5	SC65D028	Longlife+
6	SC66D028	Longlife+

CODE	TECHNOLOGY
SC61D283	Zenith
SC62D283	Zenith
SC63D283	BiPower
SC6XD283	XtraFine
SC64D283	Longlife+
SC65D283	Longlife+
SC66D283	Longlife+

CODE	TECHNOLOGY
SC61I20	Zenith
SC62I20	Zenith
SC63I20	BiPower
SC6XI20	XtraFine
SC64I40	Longlife+
SC65I40	Longlife+
SC66I40	Longlife+

POS.	CODE	TECHNOLOGY
1	SC61D445	Zenith
2	SC62D445	Zenith
3	SC63D445	BiPower
3X	SC6XD445	XtraFine
4	SC64D445	Longlife+
5	SC65D445	Longlife+
6	SC66D445	Longlife+

CODE	TECHNOLOGY
SC61I22	Zenith
SC62I22	Zenith
SC63I22	BiPower
SC6XI22	XtraFine
SC64I22	Longlife+
SC65I22	Longlife+
SC66I22	Longlife+

CODE	TECHNOLOGY
SC61I21	Zenith
SC62I21	Zenith
SC63I21	BiPower
SC6XI21	XtraFine
SC64I21	Longlife+
SC65I21	Longlife+
SC66I21	Longlife+

### Electroplated Kit ●

### Electroplated Kit ●

### Electroplated Kit ●

### Electroplated Kit ●

### Electroplated Kit ●

### Electroplated Kit ●

POS.	CODE	TECHNOLOGY
1	SC67D028	Electroplated
2	SC68D028	Electroplated
3	SC63D028	BiPower
4	SC64D028	Longlife+
5	SC65D028	Longlife+
6	SC66D028	Longlife+

CODE	TECHNOLOGY
SC67D283	Electroplated
SC68D283	Electroplated
SC63D283	BiPower
SC64D283	Longlife+
SC65D283	Longlife+
SC66D283	Longlife+

CODE	TECHNOLOGY
SC67I20	Electroplated
SC68I20	Electroplated
SC63I20	BiPower
SC64I40	Longlife+
SC65I40	Longlife+
SC66I40	Longlife+

POS.	CODE	TECHNOLOGY
1	SC67D445	Electroplated
2	SC68D445	Electroplated
3	SC63D445	BiPower
4	SC64D445	Longlife+
5	SC65D445	Longlife+
6	SC66D445	Longlife+

CODE	TECHNOLOGY
SC67I22	Electroplated
SC68I22	Electroplated
SC63I22	BiPower
SC64I22	Longlife+
SC65I22	Longlife+
SC66I22	Longlife+

CODE	TECHNOLOGY
SC67I21	Electroplated
SC68I21	Electroplated
SC63I21	BiPower
SC64I21	Longlife+
SC65I21	Longlife+
SC66I21	Longlife+



## YS40 3x3

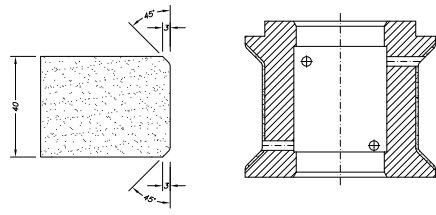

## Z20

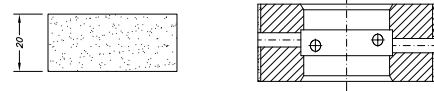

## Z30

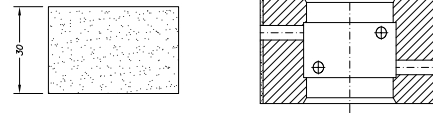

## Z40

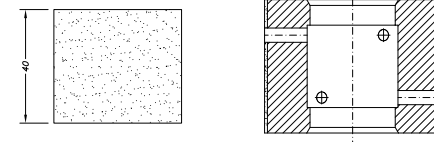

## Z50

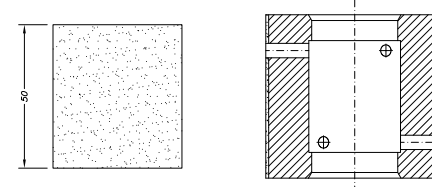

## Z60

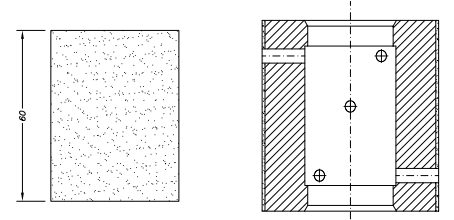

### EHS Kit ▲ ■ ●

POS.	CODE	TECHNOLOGY
1	SCE61124	EHS
2	SCE62124	EHS
3	SCE63124	EHS
4	SC64124	Longlife+
5	SC65124	Longlife+
6	SC66124	Longlife+

### EHS Kit ▲ ■ ●

CODE	TECHNOLOGY
SCE61033	EHS
SCE62033	EHS
SCE63033	EHS
SC64033	Longlife+
SC65033	Longlife+
SC66033	Longlife+

### EHS Kit ▲ ■ ●

CODE	TECHNOLOGY
SCE61034	EHS
SCE62034	EHS
SCE63034	EHS
SC64034	Longlife+
SC65034	Longlife+
SC66034	Longlife+

### EHS Kit ▲ ■ ●

POS.	CODE	TECHNOLOGY
1	SCE61035	EHS
2	SCE62035	EHS
3	SCE63035	EHS
4	SC64035	Longlife+
5	SC65035	Longlife+
6	SC66035	Longlife+

### EHS Kit ▲ ■ ●

CODE	TECHNOLOGY
SCE61036	EHS
SCE62036	EHS
SCE63036	EHS
SC64036	Longlife+
SC65036	Longlife+
SC66036	Longlife+

### EHS Kit ▲ ■ ●

CODE	TECHNOLOGY
SCG61037	EHS
SC62037	EHS
SC63037	EHS
SC64037	Longlife+
SC65037	Longlife+
SC66037	Longlife+

### Standard Kit ▲ ■ ●

POS.	CODE	TECHNOLOGY
1	SC61124	Zenith
2	SC62124	Zenith
3	SC63124	BiPower
3X	SC6X124	XtraFine
4	SC64124	Longlife+
5	SC65124	Longlife+
6	SC66124	Longlife+

### Standard Kit ▲ ■ ●

CODE	TECHNOLOGY
SC61033	Zenith
SC62033	Zenith
SC63033	BiPower
SC6X033	XtraFine
SC64033	Longlife+
SC65033	Longlife+
SC66033	Longlife+

### Standard Kit ▲ ■ ●

CODE	TECHNOLOGY
SC61034	Zenith
SC62034	Zenith
SC63034	BiPower
SC6X034	XtraFine
SC64034	Longlife+
SC65034	Longlife+
SC66034	Longlife+

### Standard Kit ▲ ■ ●

POS.	CODE	TECHNOLOGY
1	SC61035	Zenith
2	SC62035	Zenith
3	SC63035	BiPower
3X	SC6X035	XtraFine
4	SC64035	Longlife+
5	SC65035	Longlife+
6	SC66035	Longlife+

### Standard Kit ▲ ■ ●

CODE	TECHNOLOGY
SC61036	Zenith
SC62036	Zenith
SC63036	BiPower
SC6X036	XtraFine
SC64036	Longlife+
SC65036	Longlife+
SC66036	Longlife+

### Standard Kit ▲ ■ ●

CODE	TECHNOLOGY
SCG61037	Zenith
SC62037	Zenith
SC63037	BiPower
SC6X037	XtraFine
SC64037	Longlife+
SC65037	Longlife+
SC66037	Longlife+

### Electroplated Kit ●

POS.	CODE	TECHNOLOGY
1	SC67124	Electroplated
2	SC68124	Electroplated
3	SC63124	BiPower
4	SC64124	Longlife+
5	SC65124	Longlife+
6	SC66124	Longlife+

### Electroplated Kit ●

CODE	TECHNOLOGY
SC67033	Electroplated
SC68033	Electroplated
SC63033	BiPower
SC64033	Longlife+
SC65033	Longlife+
SC66033	Longlife+

### Electroplated Kit ●

CODE	TECHNOLOGY
SC67034	Electroplated
SC68034	Electroplated
SC63034	BiPower
SC64034	Longlife+
SC65034	Longlife+
SC66034	Longlife+

### Electroplated Kit ●

POS.	CODE	TECHNOLOGY
1	SC67035	Electroplated
2	SC68035	Electroplated
3	SC63035	BiPower
4	SC64035	Longlife+
5	SC65035	Longlife+
6	SC66035	Longlife+

### Electroplated Kit ●

CODE	TECHNOLOGY
SC67036	Electroplated
SC68036	Electroplated
SC63036	BiPower
SC64036	Longlife+
SC65036	Longlife+
SC66036	Longlife+

### Electroplated Kit ●

CODE	TECHNOLOGY
SCG67037	Electroplated
SC68037	Electroplated
SC63037	BiPower
SC64037	Longlife+
SC65037	Longlife+
SC66037	Longlife+

### Glossforce3.0

POS.	CODE	TECHNOLOGY
4	SCG64036	GlossForce 3.0
5	SCG65036	GlossForce 3.0
6	SCG66036	GlossForce 3.0



## ZS20

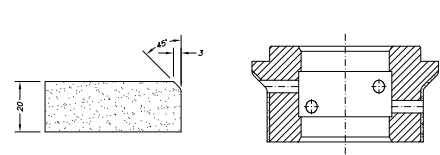

## ZS30

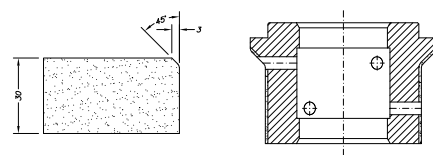

## ZS40

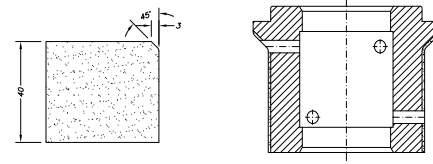

### EHS Kit ▲ ■ ●

POS.	CODE	TECHNOLOGY
1	SCE61040	EHS
2	SCE62040	EHS
3	SCE63040	EHS
4	SC64040	Longlife+
5	SC65040	Longlife+
6	SC66040	Longlife+

### EHS Kit ▲ ■ ●

CODE	TECHNOLOGY
SCE61041	EHS
SCE62041	EHS
SCE63041	EHS
SC64041	Longlife+
SC65041	Longlife+
SC66041	Longlife+

### EHS Kit ▲ ■ ●

CODE	TECHNOLOGY
SCE61042	EHS
SCE62042	EHS
SCE63042	EHS
SC64042	Longlife+
SC65042	Longlife+
SC66042	Longlife+

### Standard Kit ▲ ■ ●

POS.	CODE	TECHNOLOGY
1	SC61040	Zenith
2	SC62040	Zenith
3	SC63040	BiPower
3X	SC6X040	XtraFine
4	SC64040	Longlife+
5	SC65040	Longlife+
6	SC66040	Longlife+

### Standard Kit ▲ ■ ●

CODE	TECHNOLOGY
SC61041	Zenith
SC62041	Zenith
SC63041	BiPower
SC6X041	XtraFine
SC64041	Longlife+
SC65041	Longlife+
SC66041	Longlife+

### Standard Kit ▲ ■ ●

CODE	TECHNOLOGY
SC61042	Zenith
SC62042	Zenith
SC63042	BiPower
SC6X042	XtraFine
SC64042	Longlife+
SC65042	Longlife+
SC66042	Longlife+

### Electroplated Kit ●

POS.	CODE	TECHNOLOGY
1	SC67040	Electroplated
2	SC68040	Electroplated
3	SC63040	BiPower
4	SC64040	Longlife+
5	SC65040	Longlife+
6	SC66040	Longlife+

### Electroplated Kit ●

CODE	TECHNOLOGY
SC67041	Electroplated
SC68041	Electroplated
SC63041	BiPower
SC64041	Longlife+
SC65041	Longlife+
SC66041	Longlife+

### Electroplated Kit ●

CODE	TECHNOLOGY
SC67042	Electroplated
SC68042	Electroplated
SC63042	BiPower
SC64042	Longlife+
SC65042	Longlife+
SC66042	Longlife+

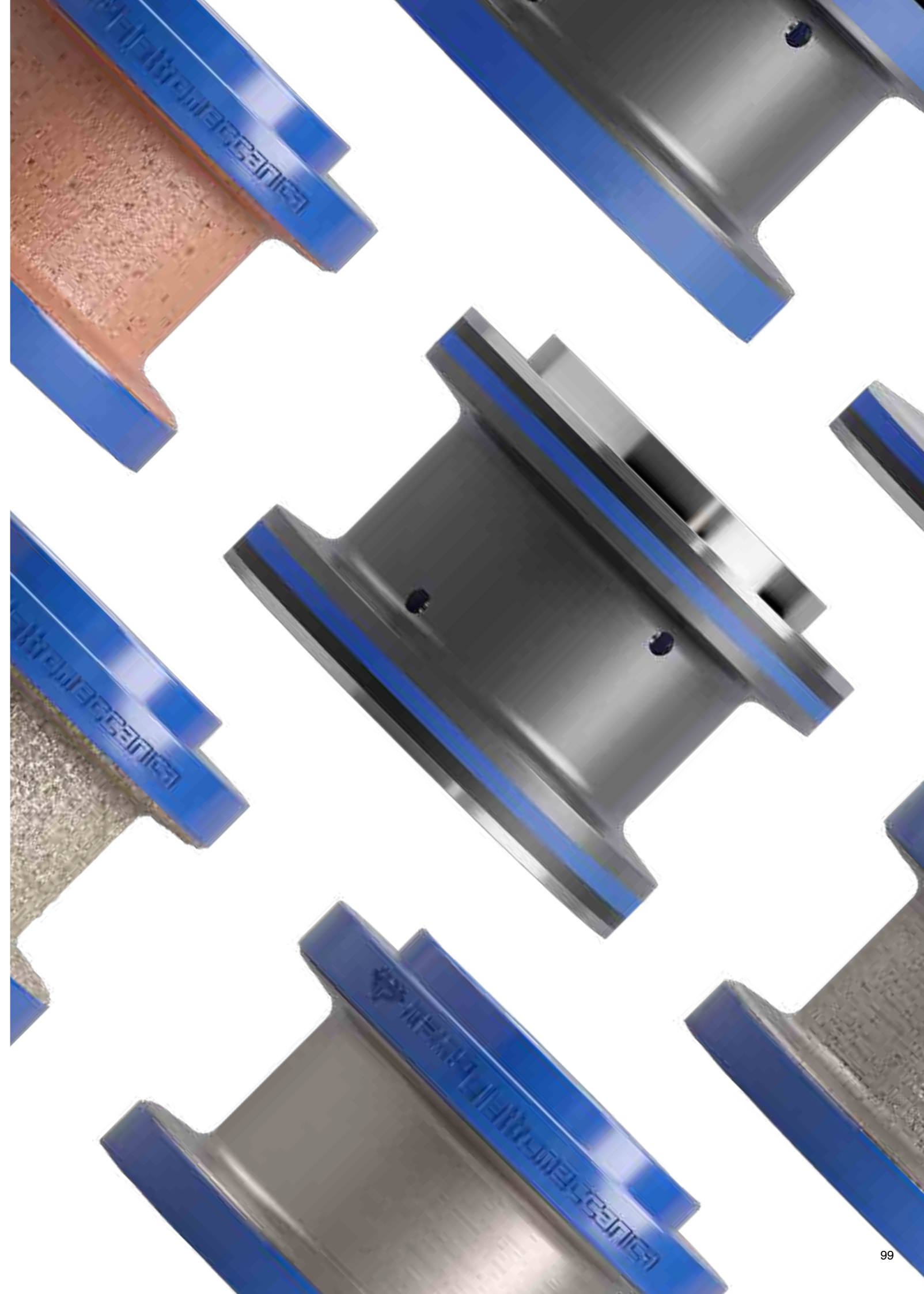



Unleash versatility and finesse with Line 40, the choice for internal and external profiling. Crafted with a 40mm diameter, Line 40 creates a 20mm radius in sinkhole corners while excelling in high feed rates on edges. Choose from EHS, Standard, and Electroplated technologies for precision. Seamlessly integrate using a 22mm bore fitting. Line 40 sets the stage for efficient and polished countertop production.

Unleash creativity. We welcome custom profiles, fitting tweaks, and Electroplated technology. Elevate your CNC experience with tailored precision.

# Line 40





**EHS Kit**  
High speed, all materials

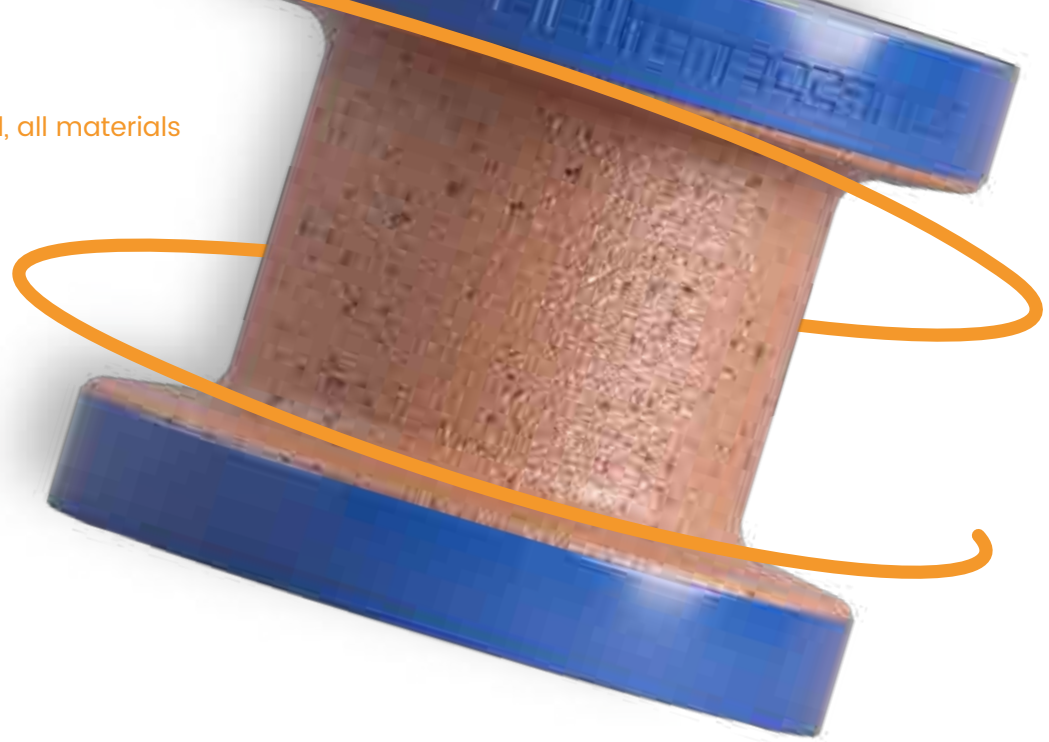

**0**

Pre-cutting



**Hyper-Z**  
For granite, ceramic and quartz

**Standard Kit**  
All materials

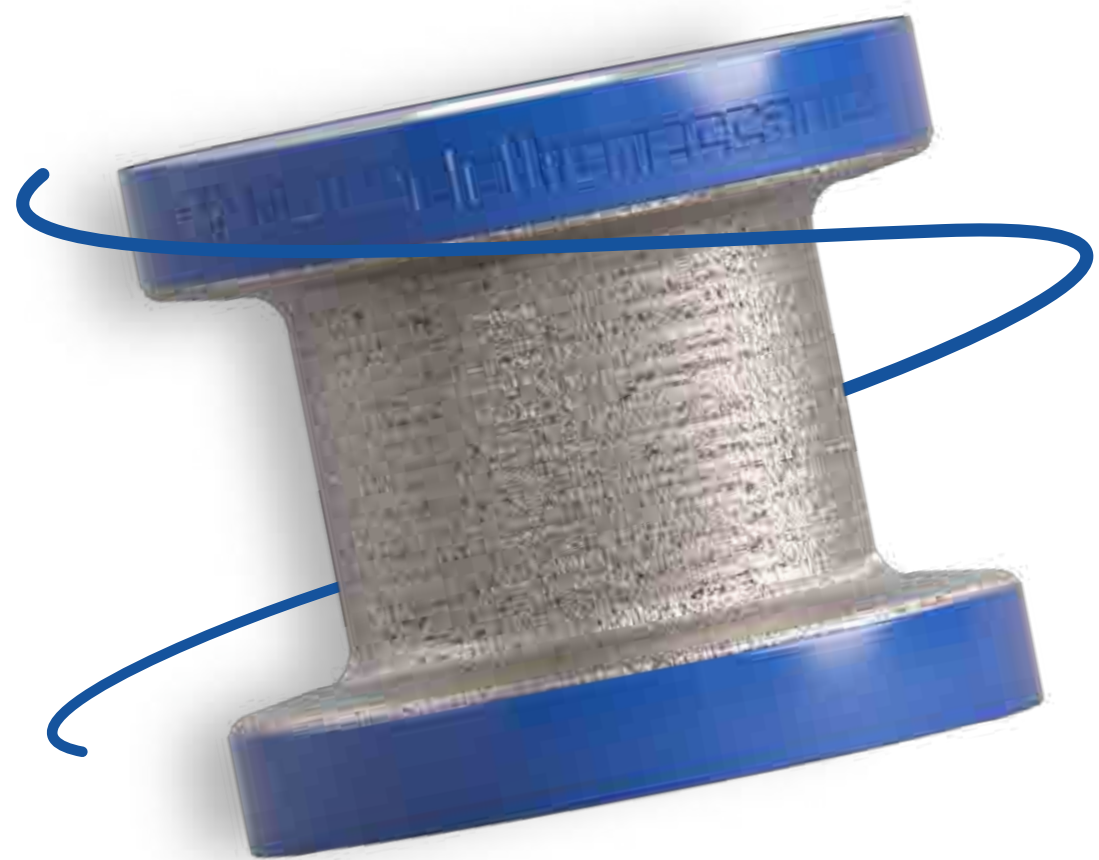

**Electroplated Kit**  
Soft materials, marble



# Position



1

Profiling

2

Profiling

3

Profiling

4

Polishing

5

Polishing

6

Polishing

EHS Kit



**EHS - Extra High Speed**  
Universal



**GLOSSFORCE 3.0**  
Universal



Standard Kit



**ZENITH**  
Universal



**BIPOWER**  
Universal

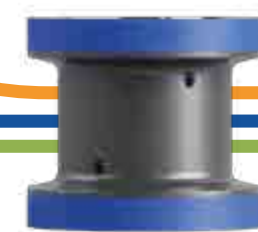

**LOGLIFE+**  
Universal

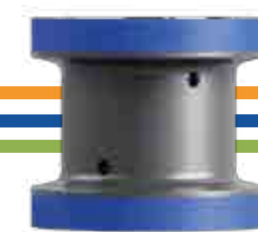

Electroplated Kit



**ELECTROPLATED**  
Marble

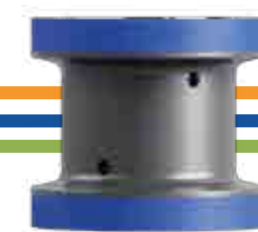
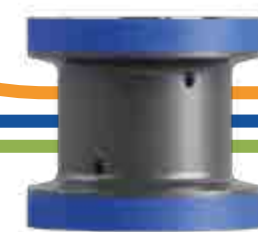



# Line 40 Profiles

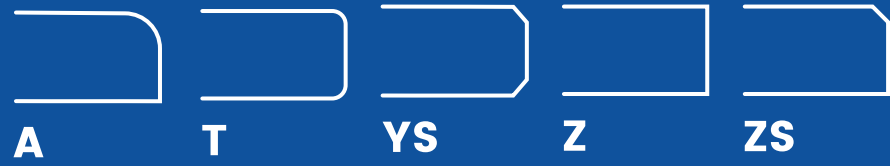

\* Custom designed profiles are accepted

## Hyper-Z



HYPER Z CLEANER			
POS.	CODE	DESCRIPTION	FITTING
CLEANER	SC01440	Ø40 - H45	Bore 22
CLEANER	SC01441	Ø40 - H45	Bore 22



## A20 r5

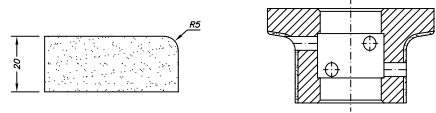

## A20 r5 DEC

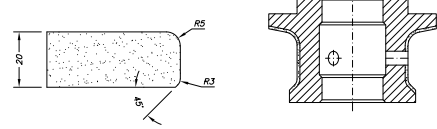

## A30 r3

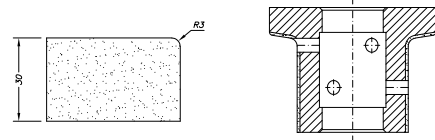

## A30 r3 DEC

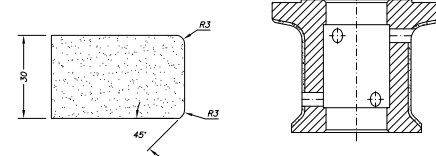

## A30 r5

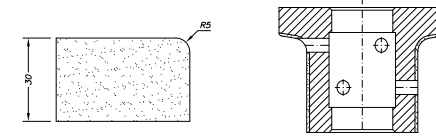

## A30 r5 Pfd DEC

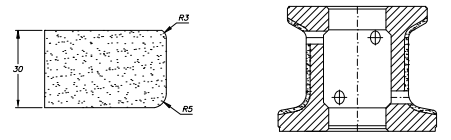

### EHS Kit ▲ ■ ●

POS.	CODE	TECHNOLOGY
1	SCE41001	EHS
2	SCE42001	EHS
3	SCE43001	EHS
4	SC44001	Longlife+
5	SC45001	Longlife+
6	SC46001	Longlife+

### EHS Kit ▲ ■ ●

POS.	CODE	TECHNOLOGY
1	SCE41D523	EHS
2	SCE42D523	EHS
3	SCE43D523	EHS
4	SC44D523	Longlife+
5	SC45D523	Longlife+
6	SC46D523	Longlife+

### EHS Kit ▲ ■ ●

POS.	CODE	TECHNOLOGY
1	SCE41004	EHS
2	SCE42004	EHS
3	SCE43004	EHS
4	SC44004	Longlife+
5	SC45004	Longlife+
6	SC46004	Longlife+

### EHS Kit ▲ ■ ●

POS.	CODE	TECHNOLOGY
1	SCE41D239	EHS
2	SCE42D239	EHS
3	SCE43D239	EHS
4	SC44D239	Longlife+
5	SC45D239	Longlife+
6	SC46D239	Longlife+

### EHS Kit ▲ ■ ●

POS.	CODE	TECHNOLOGY
1	SCE41005	EHS
2	SCE42005	EHS
3	SCE43005	EHS
4	SC44005	Longlife+
5	SC45005	Longlife+
6	SC46005	Longlife+

### EHS Kit ▲ ■ ●

POS.	CODE	TECHNOLOGY
1	SCE41199	EHS
2	SCE42199	EHS
3	SCE43199	EHS
4	SC44199	Longlife+
5	SC45199	Longlife+
6	SC46199	Longlife+

### Standard Kit ▲ ■ ●

POS.	CODE	TECHNOLOGY
1	SC41001	Zenith
2	SC42001	Zenith
3	SC43001	BiPower
3X	SC4X001	XtraFine
4	SC44001	Longlife+
5	SC45001	Longlife+
6	SC46001	Longlife+

### Standard Kit ▲ ■ ●

POS.	CODE	TECHNOLOGY
1	SC41D523	Zenith
2	SC42D523	Zenith
3	SC43D523	BiPower
3X	SC4XD523	XtraFine
4	SC44D523	Longlife+
5	SC45D523	Longlife+
6	SC46D523	Longlife+

### Standard Kit ▲ ■ ●

POS.	CODE	TECHNOLOGY
1	SC41004	Zenith
2	SC42004	Zenith
3	SC43004	BiPower
3X	SC4X004	XtraFine
4	SC44004	Longlife+
5	SC45004	Longlife+
6	SC46004	Longlife+

### Standard Kit ▲ ■ ●

POS.	CODE	TECHNOLOGY
1	SC41D239	Zenith
2	SC42D239	Zenith
3	SC43D239	BiPower
3X	SC4XD239	XtraFine
4	SC44D239	Longlife+
5	SC45D239	Longlife+
6	SC46D239	Longlife+

### Standard Kit ▲ ■ ●

POS.	CODE	TECHNOLOGY
1	SC41005	Zenith
2	SC42005	Zenith
3	SC43005	BiPower
3X	SC4X005	XtraFine
4	SC44005	Longlife+
5	SC45005	Longlife+
6	SC46005	Longlife+

### Standard Kit ▲ ■ ●

POS.	CODE	TECHNOLOGY
1	SC41199	Zenith
2	SC42199	Zenith
3	SC43199	BiPower
3X	SC4X199	XtraFine
4	SC44199	Longlife+
5	SC45199	Longlife+
6	SC46199	Longlife+

### Electroplated Kit ●

POS.	CODE	TECHNOLOGY
1	SC47001	Electroplated
2	SC48001	Electroplated
3	SC43001	BiPower
4	SC44001	Longlife+
5	SC45001	Longlife+
6	SC46001	Longlife+

### Electroplated Kit ●

POS.	CODE	TECHNOLOGY
1	SC47D523	Electroplated
2	SC48D523	Electroplated
3	SC43D523	BiPower
4	SC44D523	Longlife+
5	SC45D523	Longlife+
6	SC46D523	Longlife+

### Electroplated Kit ●

POS.	CODE	TECHNOLOGY
1	SC47004	Electroplated
2	SC48004	Electroplated
3	SC43004	BiPower
4	SC44004	Longlife+
5	SC45004	Longlife+
6	SC46004	Longlife+

### Electroplated Kit ●

POS.	CODE	TECHNOLOGY
1	SC47D239	Electroplated
2	SC48D239	Electroplated
3	SC43D239	BiPower
4	SC44D239	Longlife+
5	SC45D239	Longlife+
6	SC46D239	Longlife+

### Electroplated Kit ●

POS.	CODE	TECHNOLOGY
1	SC47005	Electroplated
2	SC48005	Electroplated
3	SC43005	BiPower
4	SC44005	Longlife+
5	SC45005	Longlife+
6	SC46005	Longlife+

### Electroplated Kit ●

POS.	CODE	TECHNOLOGY
1	SC47199	Electroplated
2	SC48199	Electroplated
3	SC43199	BiPower
4	SC44199	Longlife+
5	SC45199	Longlife+
6	SC46199	Longlife+

### Glossforce3.0

POS.	CODE	TECHNOLOGY
4	SCG44004	GlossForce 3.0
5	SCG45004	GlossForce 3.0
6	SCG46004	GlossForce 3.0



## A30 r6

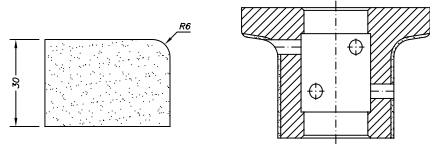

## T12 r2.5

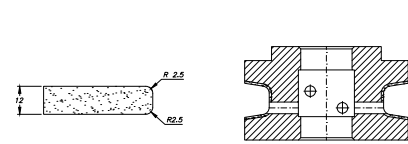

## T20 r3

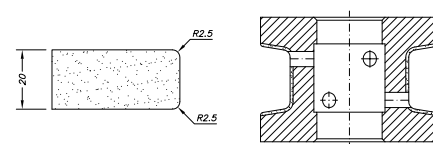

## T20 r5

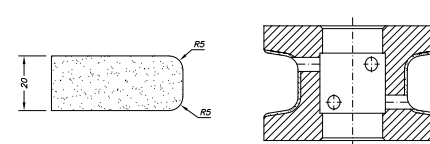

## T30 r3

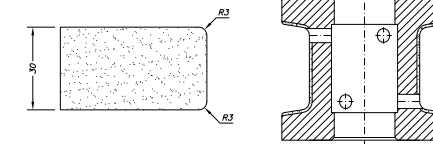

## T30 r4

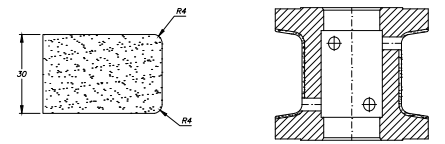

### EHS Kit ▲ ■ ●

POS.	CODE	TECHNOLOGY
1	SCE41006	EHS
2	SCE42006	EHS
3	SCE43006	EHS
4	SC44006	Longlife+
5	SC45006	Longlife+
6	SC46006	Longlife+

### EHS Kit ▲ ■ ●

POS.	CODE	TECHNOLOGY
1	SCE41D168	EHS
2	SCE42D168	EHS
3	SCE43D168	EHS
4	SC44D168	Longlife+
5	SC45D168	Longlife+
6	SC46D168	Longlife+

### EHS Kit ▲ ■ ●

POS.	CODE	TECHNOLOGY
1	SCE41I14	EHS
2	SCE42I14	EHS
3	SCE43I14	EHS
4	SC44I14	Longlife+
5	SC45I14	Longlife+
6	SC46I14	Longlife+

### EHS Kit ▲ ■ ●

POS.	CODE	TECHNOLOGY
1	SCE41080	EHS
2	SCE42080	EHS
3	SCE43080	EHS
4	SC44080	Longlife+
5	SC45080	Longlife+
6	SC46080	Longlife+

### EHS Kit ▲ ■ ●

POS.	CODE	TECHNOLOGY
1	SCE41I15	EHS
2	SCE42I15	EHS
3	SCE43I15	EHS
4	SC44I15	Longlife+
5	SC45I15	Longlife+
6	SC46I15	Longlife+

### EHS Kit ▲ ■ ●

POS.	CODE	TECHNOLOGY
1	SCE41444	EHS
2	SCE42444	EHS
3	SCE43444	EHS
4	SC44444	Longlife+
5	SC45444	Longlife+
6	SC46444	Longlife+

### Standard Kit ▲ ■ ●

POS.	CODE	TECHNOLOGY
1	SC41006	Zenith
2	SC42006	Zenith
3	SC43006	BiPower
3X	SC4X006	XtraFine
4	SC44006	Longlife+
5	SC45006	Longlife+
6	SC46006	Longlife+

### Standard Kit ▲ ■ ●

POS.	CODE	TECHNOLOGY
1	SC41D168	Zenith
2	SC42D168	Zenith
3	SC43D168	BiPower
3X	SC4XD168	XtraFine
4	SC44D168	Longlife+
5	SC45D168	Longlife+
6	SC46D168	Longlife+

### Standard Kit ▲ ■ ●

POS.	CODE	TECHNOLOGY
1	SC41I14	Zenith
2	SC42I14	Zenith
3	SC43I14	BiPower
3X	SC4XI14	XtraFine
4	SC44I14	Longlife+
5	SC45I14	Longlife+
6	SC46I14	Longlife+

### Standard Kit ▲ ■ ●

POS.	CODE	TECHNOLOGY
1	SC41080	Zenith
2	SC42080	Zenith
3	SC43080	BiPower
3X	SC4X080	XtraFine
4	SC44080	Longlife+
5	SC45080	Longlife+
6	SC46080	Longlife+

### Standard Kit ▲ ■ ●

POS.	CODE	TECHNOLOGY
1	SC41I15	Zenith
2	SC42I15	Zenith
3	SC43I15	BiPower
3X	SC4XI15	XtraFine
4	SC44I15	Longlife+
5	SC45I15	Longlife+
6	SC46I15	Longlife+

### Standard Kit ▲ ■ ●

POS.	CODE	TECHNOLOGY
1	SC41444	Zenith
2	SC42444	Zenith
3	SC43444	BiPower
3X	SC4X444	XtraFine
4	SC44444	Longlife+
5	SC45444	Longlife+
6	SC46444	Longlife+

### Electroplated Kit ●

POS.	CODE	TECHNOLOGY
1	SC47006	Electroplated
2	SC48006	Electroplated
3	SC43006	BiPower
4	SC44006	Longlife+
5	SC45006	Longlife+
6	SC46006	Longlife+

### Electroplated Kit ●

POS.	CODE	TECHNOLOGY
1	SC47D168	Electroplated
2	SC48D168	Electroplated
3	SC43D168	BiPower
4	SC44D168	Longlife+
5	SC45D168	Longlife+
6	SC46D168	Longlife+

### Electroplated Kit ●

POS.	CODE	TECHNOLOGY
1	SC47I14	Electroplated
2	SC48I14	Electroplated
3	SC43I14	BiPower
4	SC44I14	Longlife+
5	SC45I14	Longlife+
6	SC46I14	Longlife+

### Electroplated Kit ●

POS.	CODE	TECHNOLOGY
1	SC47080	Electroplated
2	SC48080	Electroplated
3	SC43080	BiPower
4	SC44080	Longlife+
5	SC45080	Longlife+
6	SC46080	Longlife+

### Electroplated Kit ●

POS.	CODE	TECHNOLOGY
1	SC47I15	Electroplated
2	SC48I15	Electroplated
3	SC43I15	BiPower
4	SC44I15	Longlife+
5	SC45I15	Longlife+
6	SC46I15	Longlife+

### Electroplated Kit ●

POS.	CODE	TECHNOLOGY
1	SC47444	Electroplated
2	SC48444	Electroplated
3	SC43444	BiPower
4	SC44444	Longlife+
5	SC45444	Longlife+
6	SC46444	Longlife+

### Glossforce3.0

POS.	CODE	TECHNOLOGY
4	SCG44I15	GlossForce 3.0
5	SCG45I15	GlossForce 3.0
6	SCG46I15	GlossForce 3.0



## T30 r5

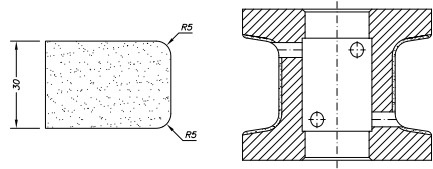

## T30 r6

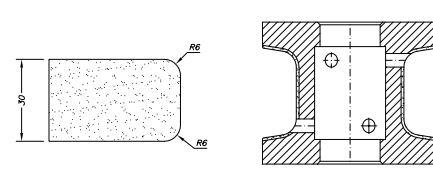

## T30 r8

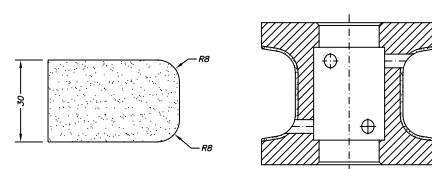

## T40 r3.5

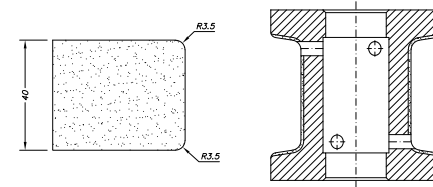

## X+D12

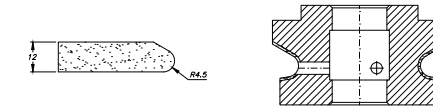

## YS12 1.5x1.5

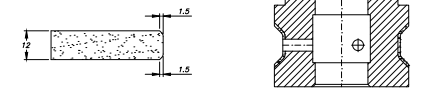

### EHS Kit ▲ ■ ●

POS.	CODE	TECHNOLOGY
1	SCE41082	EHS
2	SCE42082	EHS
3	SCE43082	EHS
4	SC44082	Longlife+
5	SC45082	Longlife+
6	SC46082	Longlife+

### EHS Kit ▲ ■ ●

POS.	CODE	TECHNOLOGY
1	SCE41D156	EHS
2	SCE42D156	EHS
3	SCE43D156	EHS
4	SC44D156	Longlife+
5	SC45D156	Longlife+
6	SC46D156	Longlife+

### EHS Kit ▲ ■ ●

POS.	CODE	TECHNOLOGY
1	SCE41D096	EHS
2	SCE42D096	EHS
3	SCE43D096	EHS
4	SC44D096	Longlife+
5	SC45D096	Longlife+
6	SC46D096	Longlife+

### EHS Kit ▲ ■ ●

POS.	CODE	TECHNOLOGY
1	SCE41117	EHS
2	SCE42117	EHS
3	SCE43117	EHS
4	SC44117	Longlife+
5	SC45117	Longlife+
6	SC46117	Longlife+

### EHS Kit ▲ ■ ●

POS.	CODE	TECHNOLOGY
1	SCE41110	EHS
2	SCE42110	EHS
3	SCE43110	EHS
4	SC44110	Longlife+
5	SC45110	Longlife+
6	SC46110	Longlife+

### EHS Kit ▲ ■ ●

POS.	CODE	TECHNOLOGY
1	SCE41D191	EHS
2	SCE42D191	EHS
3	SCE43D191	EHS
4	SC44D191	Longlife+
5	SC45D191	Longlife+
6	SC46D191	Longlife+

### Standard Kit ▲ ■ ●

POS.	CODE	TECHNOLOGY
1	SC41082	Zenith
2	SC42082	Zenith
3	SC43082	BiPower
3X	SC4X082	XtraFine
4	SC44082	Longlife+
5	SC45082	Longlife+
6	SC46082	Longlife+

### Standard Kit ▲ ■ ●

POS.	CODE	TECHNOLOGY
1	SC41D156	Zenith
2	SC42D156	Zenith
3	SC43D156	BiPower
3X	SC4XD156	XtraFine
4	SC44D156	Longlife+
5	SC45D156	Longlife+
6	SC46D156	Longlife+

### Standard Kit ▲ ■ ●

POS.	CODE	TECHNOLOGY
1	SC41D096	Zenith
2	SC42D096	Zenith
3	SC43D096	BiPower
3X	SC4XD096	XtraFine
4	SC44D096	Longlife+
5	SC45D096	Longlife+
6	SC46D096	Longlife+

### Standard Kit ▲ ■ ●

POS.	CODE	TECHNOLOGY
1	SC41117	Zenith
2	SC42117	Zenith
3	SC43117	BiPower
3X	SC4X117	XtraFine
4	SC44117	Longlife+
5	SC45117	Longlife+
6	SC46117	Longlife+

### Standard Kit ▲ ■ ●

POS.	CODE	TECHNOLOGY
1	SC41110	Zenith
2	SC42110	Zenith
3	SC43110	BiPower
3X	SC4X110	XtraFine
4	SC44110	Longlife+
5	SC45110	Longlife+
6	SC46110	Longlife+

### Standard Kit ▲ ■ ●

POS.	CODE	TECHNOLOGY
1	SC41D191	Zenith
2	SC42D191	Zenith
3	SC43D191	BiPower
3X	SC4XD191	XtraFine
4	SC44D191	Longlife+
5	SC45D191	Longlife+
6	SC46D191	Longlife+

### Electroplated Kit ●

POS.	CODE	TECHNOLOGY
1	SC47082	Electroplated
2	SC48082	Electroplated
3	SC43082	BiPower
4	SC44082	Longlife+
5	SC45082	Longlife+
6	SC46082	Longlife+

### Electroplated Kit ●

POS.	CODE	TECHNOLOGY
1	SC47D156	Electroplated
2	SC48D156	Electroplated
3	SC43D156	BiPower
4	SC44D156	Longlife+
5	SC45D156	Longlife+
6	SC46D156	Longlife+

### Electroplated Kit ●

POS.	CODE	TECHNOLOGY
1	SC47D096	Electroplated
2	SC48D096	Electroplated
3	SC43D096	BiPower
4	SC44D096	Longlife+
5	SC45D096	Longlife+
6	SC46D096	Longlife+

### Electroplated Kit ●

POS.	CODE	TECHNOLOGY
1	SC47117	Electroplated
2	SC48117	Electroplated
3	SC43117	BiPower
4	SC44117	Longlife+
5	SC45117	Longlife+
6	SC46117	Longlife+

### Electroplated Kit ●

POS.	CODE	TECHNOLOGY
1	SC47110	Electroplated
2	SC48110	Electroplated
3	SC43110	BiPower
4	SC44110	Longlife+
5	SC45110	Longlife+
6	SC46110	Longlife+

### Electroplated Kit ●

POS.	CODE	TECHNOLOGY
1	SC47D191	Electroplated
2	SC48D191	Electroplated
3	SC43D191	BiPower
4	SC44D191	Longlife+
5	SC45D191	Longlife+
6	SC46D191	Longlife+





## YS20 1.5x1.5

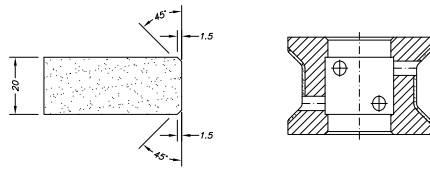

## YS20 2x2

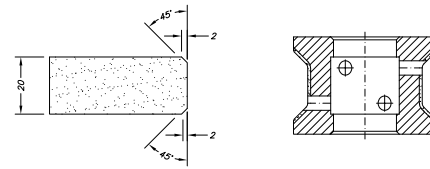

## YS20 3x3

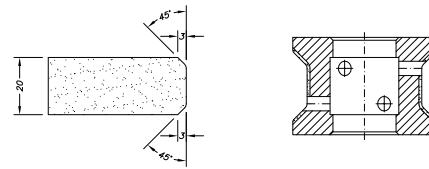

## YS30 1.5x1.5

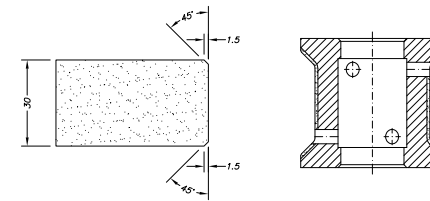

## YS30 2x2

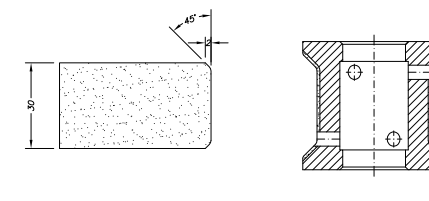

## YS30 3x3

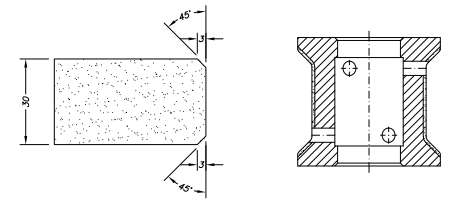

### EHS Kit ▲ ■ ●

POS.	CODE	TECHNOLOGY
1	SCE4ID028	EHS
2	SCE42D028	EHS
3	SCE43D028	EHS
4	SC44D028	Longlife+
5	SC45D028	Longlife+
6	SC46D028	Longlife+

### EHS Kit ▲ ■ ●

POS.	CODE	TECHNOLOGY
1	SCE4ID283	EHS
2	SCE42D283	EHS
3	SCE43D283	EHS
4	SC44D283	Longlife+
5	SC45D283	Longlife+
6	SC46D283	Longlife+

### EHS Kit ▲ ■ ●

POS.	CODE	TECHNOLOGY
1	SCE4I120	EHS
2	SCE42I20	EHS
3	SCE43I20	EHS
4	SC44I20	Longlife+
5	SC45I20	Longlife+
6	SC46I20	Longlife+

### EHS Kit ▲ ■ ●

POS.	CODE	TECHNOLOGY
1	SCE4ID445	EHS
2	SCE42D445	EHS
3	SCE43D445	EHS
4	SC44D445	Longlife+
5	SC45D445	Longlife+
6	SC46D445	Longlife+

### EHS Kit ▲ ■ ●

POS.	CODE	TECHNOLOGY
1	SCE4I122	EHS
2	SCE42I22	EHS
3	SCE43I22	EHS
4	SC44I22	Longlife+
5	SC45I22	Longlife+
6	SC46I22	Longlife+

### EHS Kit ▲ ■ ●

POS.	CODE	TECHNOLOGY
1	SCE4I121	EHS
2	SCE42I21	EHS
3	SCE43I21	EHS
4	SC44I21	Longlife+
5	SC45I21	Longlife+
6	SC46I21	Longlife+

### Standard Kit ▲ ■ ●

POS.	CODE	TECHNOLOGY
1	SC4ID028	Zenith
2	SC42D028	Zenith
3	SC43D028	BiPower
3X	SC4XD028	XtraFine
4	SC44D028	Longlife+
5	SC45D028	Longlife+
6	SC46D028	Longlife+

### Standard Kit ▲ ■ ●

POS.	CODE	TECHNOLOGY
1	SC4ID283	Zenith
2	SC42D283	Zenith
3	SC43D283	BiPower
3X	SC4XD283	XtraFine
4	SC44D283	Longlife+
5	SC45D283	Longlife+
6	SC46D283	Longlife+

### Standard Kit ▲ ■ ●

POS.	CODE	TECHNOLOGY
1	SC4I120	Zenith
2	SC42I20	Zenith
3	SC43I20	BiPower
3X	SC4XI20	XtraFine
4	SC44I20	Longlife+
5	SC45I20	Longlife+
6	SC46I20	Longlife+

### Standard Kit ▲ ■ ●

POS.	CODE	TECHNOLOGY
1	SC4ID445	Zenith
2	SC42D445	Zenith
3	SC43D445	BiPower
3X	SC4XD445	XtraFine
4	SC44D445	Longlife+
5	SC45D445	Longlife+
6	SC46D445	Longlife+

### Standard Kit ▲ ■ ●

POS.	CODE	TECHNOLOGY
1	SC4I122	Zenith
2	SC42I22	Zenith
3	SC43I22	BiPower
3X	SC4XI22	XtraFine
4	SC44I22	Longlife+
5	SC45I22	Longlife+
6	SC46I22	Longlife+

### Standard Kit ▲ ■ ●

POS.	CODE	TECHNOLOGY
1	SC4I121	Zenith
2	SC42I21	Zenith
3	SC43I21	BiPower
3X	SC4XI21	XtraFine
4	SC44I21	Longlife+
5	SC45I21	Longlife+
6	SC46I21	Longlife+

### Electroplated Kit ●

POS.	CODE	TECHNOLOGY
1	SC47D028	Electroplated
2	SC48D028	Electroplated
3	SC43D028	BiPower
4	SC44D028	Longlife+
5	SC45D028	Longlife+
6	SC46D028	Longlife+

### Electroplated Kit ●

POS.	CODE	TECHNOLOGY
1	SC47D283	Electroplated
2	SC48D283	Electroplated
3	SC43D283	BiPower
4	SC44D283	Longlife+
5	SC45D283	Longlife+
6	SC46D283	Longlife+

### Electroplated Kit ●

POS.	CODE	TECHNOLOGY
1	SC47I20	Electroplated
2	SC48I20	Electroplated
3	SC43I20	BiPower
4	SC44I20	Longlife+
5	SC45I20	Longlife+
6	SC46I20	Longlife+

### Electroplated Kit ●

POS.	CODE	TECHNOLOGY
1	SC47D445	Electroplated
2	SC48D445	Electroplated
3	SC43D445	BiPower
4	SC44D445	Longlife+
5	SC45D445	Longlife+
6	SC46D445	Longlife+

### Electroplated Kit ●

POS.	CODE	TECHNOLOGY
1	SC47I22	Electroplated
2	SC48I22	Electroplated
3	SC43I22	BiPower
4	SC44I22	Longlife+
5	SC45I22	Longlife+
6	SC46I22	Longlife+

### Electroplated Kit ●

POS.	CODE	TECHNOLOGY
1	SC47I21	Electroplated
2	SC48I21	Electroplated
3	SC43I21	BiPower
4	SC44I21	Longlife+
5	SC45I21	Longlife+
6	SC46I21	Longlife+



## Z30

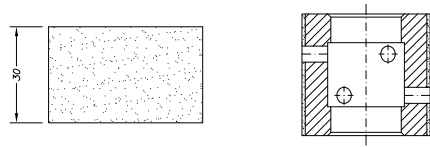

## Z40

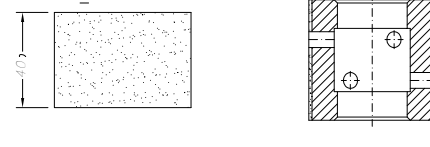

## ZS30

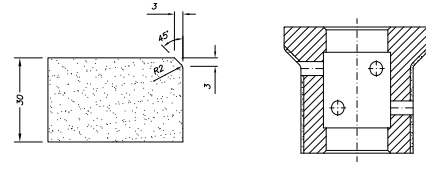

## ZS40

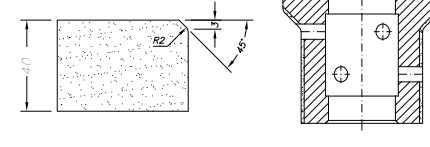

### EHS Kit ▲ ■ ●

POS.	CODE	TECHNOLOGY
1	SCE41034	EHS
2	SCE42034	EHS
3	SCE43034	EHS
4	SC44034	Longlife+
5	SC45034	Longlife+
6	SC46034	Longlife+

### EHS Kit ▲ ■ ●

POS.	CODE	TECHNOLOGY
1	SCE41035	EHS
2	SCE42035	EHS
3	SCE43035	EHS
4	SC44035	Longlife+
5	SC45035	Longlife+
6	SC46035	Longlife+

### EHS Kit ▲ ■ ●

POS.	CODE	TECHNOLOGY
1	SCE41041	EHS
2	SCE42041	EHS
3	SCE43041	EHS
4	SC44041	Longlife+
5	SC45041	Longlife+
6	SC46041	Longlife+

### EHS Kit ▲ ■ ●

POS.	CODE	TECHNOLOGY
1	SCE41042	EHS
2	SCE42042	EHS
3	SCE43042	EHS
4	SC44042	Longlife+
5	SC45042	Longlife+
6	SC46042	Longlife+

### Standard Kit ▲ ■ ●

POS.	CODE	TECHNOLOGY
1	SC41034	Zenith
2	SC42034	Zenith
3	SC43034	BiPower
3X	SC4X034	XtraFine
4	SC44034	Longlife+
5	SC45034	Longlife+
6	SC46034	Longlife+

### Standard Kit ▲ ■ ●

POS.	CODE	TECHNOLOGY
1	SC41035	Zenith
2	SC42035	Zenith
3	SC43035	BiPower
3X	SC4X035	XtraFine
4	SC44035	Longlife+
5	SC45035	Longlife+
6	SC46035	Longlife+

### Standard Kit ▲ ■ ●

POS.	CODE	TECHNOLOGY
1	SC41041	Zenith
2	SC42041	Zenith
3	SC43041	BiPower
3X	SC4X041	XtraFine
4	SC44041	Longlife+
5	SC45041	Longlife+
6	SC46041	Longlife+

### Standard Kit ▲ ■ ●

POS.	CODE	TECHNOLOGY
1	SC41042	Zenith
2	SC42042	Zenith
3	SC43042	BiPower
3X	SC4X042	XtraFine
4	SC44042	Longlife+
5	SC45042	Longlife+
6	SC46042	Longlife+

### Electroplated Kit ●

POS.	CODE	TECHNOLOGY
1	SC47034	Electroplated
2	SC48034	Electroplated
3	SC43034	BiPower
4	SC44034	Longlife+
5	SC45034	Longlife+
6	SC46034	Longlife+

### Electroplated Kit ●

POS.	CODE	TECHNOLOGY
1	SC47035	Electroplated
2	SC48035	Electroplated
3	SC43035	BiPower
4	SC44035	Longlife+
5	SC45035	Longlife+
6	SC46035	Longlife+

### Electroplated Kit ●

POS.	CODE	TECHNOLOGY
1	SC47041	Electroplated
2	SC48041	Electroplated
3	SC43041	BiPower
4	SC44041	Longlife+
5	SC45041	Longlife+
6	SC46041	Longlife+

### Electroplated Kit ●

POS.	CODE	TECHNOLOGY
1	SC47042	Electroplated
2	SC48042	Electroplated
3	SC43042	BiPower
4	SC44042	Longlife+
5	SC45042	Longlife+
6	SC46042	Longlife+

### Glossforce3.0

POS.	CODE	TECHNOLOGY
4	SCG44035	GlossForce 3.0
5	SCG45035	GlossForce 3.0
6	SCG46035	GlossForce 3.0



Experience perfection in sinkhole design with Line 20. Tailored for internal profiling, these CNC profiling wheels, with a 20mm diameter, create a 10mm radius in sinkhole corners. Choose from Standard and Electroplated technologies, providing options for every need. Seamlessly integrate using a ½" Gas fitting. Elevate your sinkhole fabrication with Line 20's precision and finesse.

Unleash creativity. We welcome custom profiles, fitting tweaks, and Electroplated technology. Elevate your CNC experience with tailored precision.

# Line 20

**EHS Kit**  
High Speed, Universal



**Standard Kit**  
Universal



**Electroplated Kit**  
Marble



**0**

Pre-cutting



**Hyper-Z**  
For granite, ceramic and quartz

# Position



**1**

Profiling

**2**

Profiling

**3**

Profiling

**4**

Polishing

**5**

Polishing

**6**

Polishing

EHS Kit



**EHS - Extra High Speed**  
Universal



**GLOSSFORCE 3.0**  
Universal



Standard Kit



**ZENITH**  
Universal



**BIPOWER**  
Universal



**LONGLIFE+**  
Universal



Electroplated Kit



**ELECTROPLATED**  
Marble

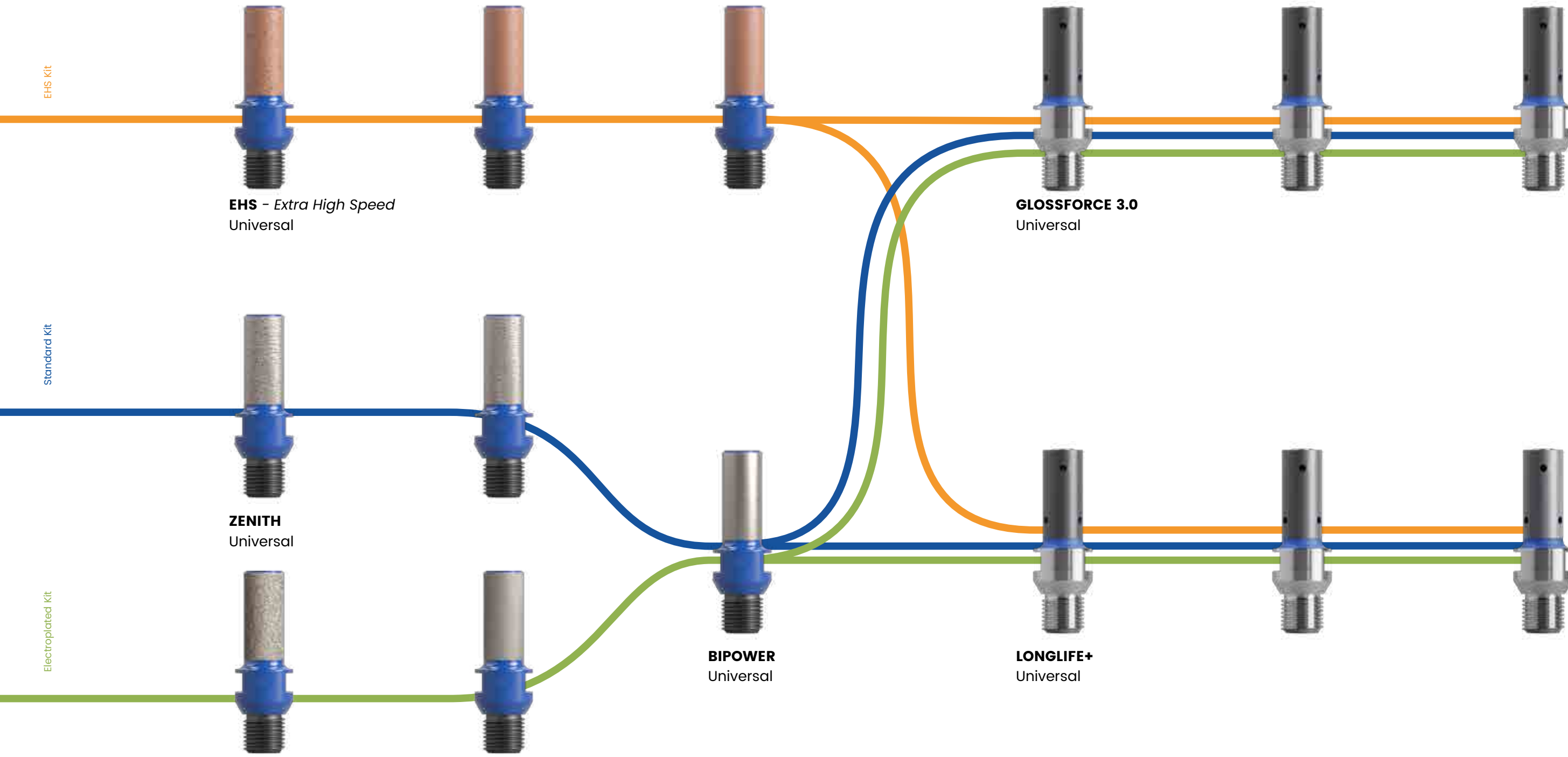





# Line 20 Profiles

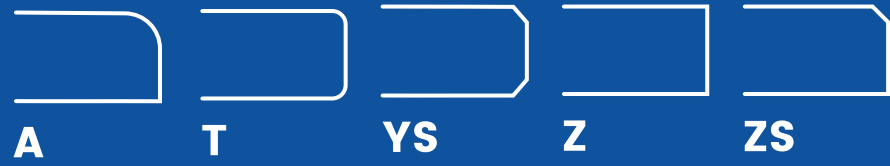

\* Custom designed profiles are accepted

## Hyper-Z



HYPER Z CLEANER			
POS.	CODE	DESCRIPTION	FITTING
CLEANER	SC01420	Ø20 - H35	½" Gas
CLEANER	SC01421	Ø20 - H36	½" Gas



## A20 r5

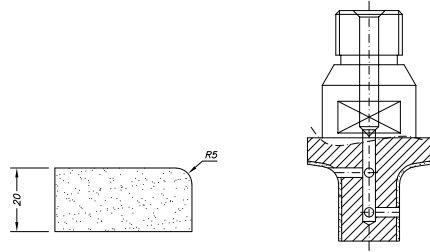

## A20 r5 Pfd

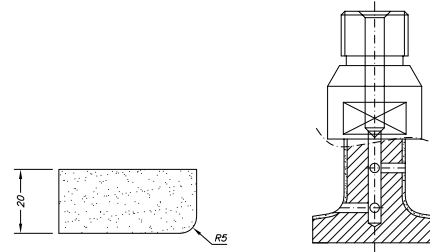

## A20 r5 DEC

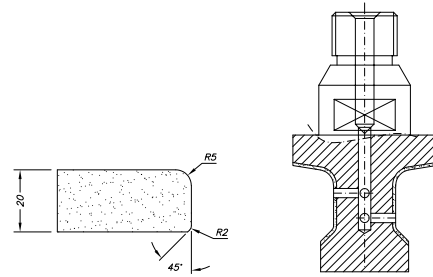

## A20 r5 Pfd DEC

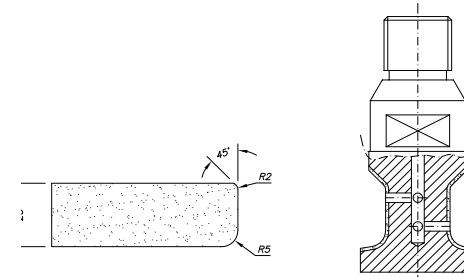

## A20 r10

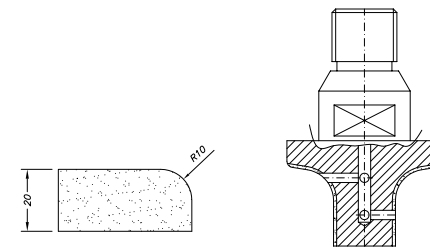

## A30 r3

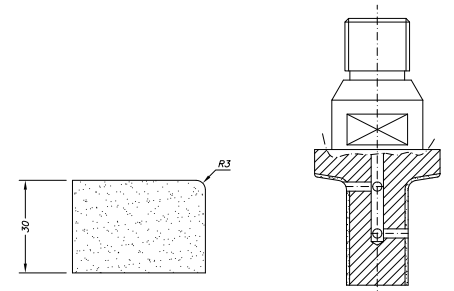

### EHS Kit ▲ ■ ●

POS.	CODE	TECHNOLOGY
1	SCE21001	EHS
2	SCE22001	EHS
3	SCE23001	EHS
4	SC24001	Longlife+
5	SC25001	Longlife+
6	SC26001	Longlife+

### EHS Kit ▲ ■ ●

CODE	TECHNOLOGY
SCE21320	EHS
SCE22320	EHS
SCE23320	EHS
SC24320	Longlife+
SC25320	Longlife+
SC26320	Longlife+

### EHS Kit ▲ ■ ●

CODE	TECHNOLOGY
SCE21D523	EHS
SCE22D523	EHS
SCE23D523	EHS
SC24D523	Longlife+
SC25D523	Longlife+
SC26D523	Longlife+

### EHS Kit ▲ ■ ●

POS.	CODE	TECHNOLOGY
1	SCE21321	EHS
2	SCE22321	EHS
3	SCE23321	EHS
4	SC24321	Longlife+
5	SC25321	Longlife+
6	SC26321	Longlife+

### EHS Kit ▲ ■ ●

CODE	TECHNOLOGY
SCE21002	EHS
SCE22002	EHS
SCE23002	EHS
SC24002	Longlife+
SC25002	Longlife+
SC26002	Longlife+

### EHS Kit ▲ ■ ●

CODE	TECHNOLOGY
SCE21004	EHS
SCE22004	EHS
SCE23004	EHS
SC24004	Longlife+
SC25004	Longlife+
SC26004	Longlife+

### Standard Kit ▲ ■ ●

POS.	CODE	TECHNOLOGY
1	SC21001	Zenith
2	SC22001	Zenith
3	SC23001	BiPower
3X	SC2X001	XtraFine
4	SC24001	Longlife+
5	SC25001	Longlife+
6	SC26001	Longlife+

### Standard Kit ▲ ■ ●

CODE	TECHNOLOGY
SC21320	Zenith
SC22320	Zenith
SC23320	BiPower
SC2X320	XtraFine
SC24320	Longlife+
SC25320	Longlife+
SC26320	Longlife+

### Standard Kit ▲ ■ ●

CODE	TECHNOLOGY
SC21D523	Zenith
SC22D523	Zenith
SC23D523	BiPower
SC2XD523	XtraFine
SC24D523	Longlife+
SC25D523	Longlife+
SC26D523	Longlife+

### Standard Kit ▲ ■ ●

POS.	CODE	TECHNOLOGY
1	SC21321	Zenith
2	SC22321	Zenith
3	SC23321	BiPower
3X	SC2X321	XtraFine
4	SC24321	Longlife+
5	SC25321	Longlife+
6	SC26321	Longlife+

### Standard Kit ▲ ■ ●

CODE	TECHNOLOGY
SC21002	Zenith
SC22002	Zenith
SC23002	BiPower
SC2X002	XtraFine
SC24002	Longlife+
SC25002	Longlife+
SC26002	Longlife+

### Standard Kit ▲ ■ ●

CODE	TECHNOLOGY
SC21004	Zenith
SC22004	Zenith
SC23004	BiPower
SC2X004	XtraFine
SC24004	Longlife+
SC25004	Longlife+
SC26004	Longlife+

### Electroplated Kit ●

POS.	CODE	TECHNOLOGY
1	SC27001	Electroplated
2	SC28001	Electroplated
3	SC23001	BiPower
4	SC24001	Longlife+
5	SC25001	Longlife+
6	SC26001	Longlife+

### Electroplated Kit ●

CODE	TECHNOLOGY
SC27320	Electroplated
SC28320	Electroplated
SC23320	BiPower
SC24320	Longlife+
SC25320	Longlife+
SC26320	Longlife+

### Electroplated Kit ●

CODE	TECHNOLOGY
SC27D523	Electroplated
SC28D523	Electroplated
SC23D523	BiPower
SC24D523	Longlife+
SC25D523	Longlife+
SC26D523	Longlife+

### Electroplated Kit ●

POS.	CODE	TECHNOLOGY
1	SC27321	Electroplated
2	SC28321	Electroplated
3	SC23321	BiPower
4	SC24321	Longlife+
5	SC25321	Longlife+
6	SC26321	Longlife+

### Electroplated Kit ●

CODE	TECHNOLOGY
SC27002	Electroplated
SC28002	Electroplated
SC23002	BiPower
SC24002	Longlife+
SC25002	Longlife+
SC26002	Longlife+

### Electroplated Kit ●

CODE	TECHNOLOGY
SC27004	Electroplated
SC28004	Electroplated
SC23004	BiPower
SC24004	Longlife+
SC25004	Longlife+
SC26004	Longlife+

### Glossforce3.0

POS.
4
5
6

CODE	TECHNOLOGY
SCG24004	GlossForce 3.0
SCG25004	GlossForce 3.0
SCG26004	GlossForce 3.0



## A30 r3 Pfd

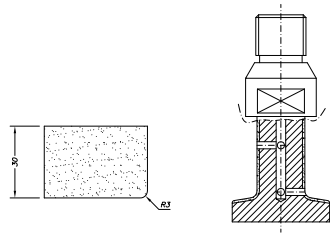

## A30 r3 DEC

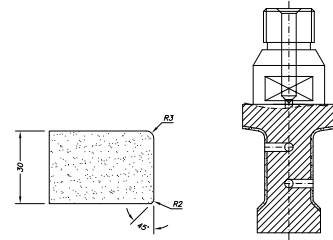

## A30 r3 Pfd DEC

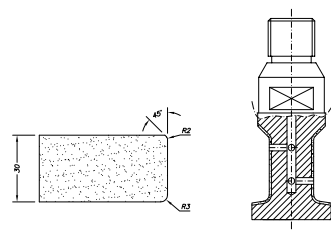

## A30 r5

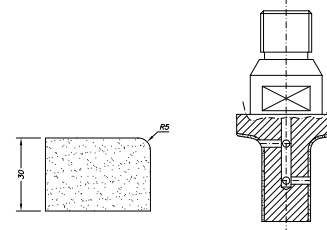

## A30 r5 Pfd

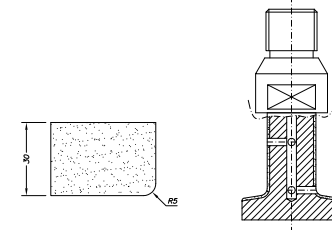

## A30 r5 DEC

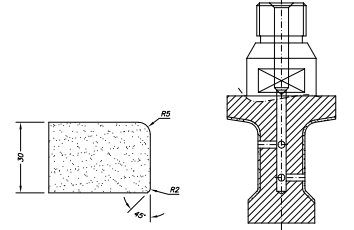

### EHS Kit ▲ ■ ●

POS.	CODE	TECHNOLOGY
1	SCE21011	EHS
2	SCE22011	EHS
3	SCE23011	EHS
4	SC24011	Longlife+
5	SC25011	Longlife+
6	SC26011	Longlife+

### EHS Kit ▲ ■ ●

CODE	TECHNOLOGY
SCE21D239	EHS
SCE22D239	EHS
SCE23D239	EHS
SC24D239	Longlife+
SC25D239	Longlife+
SC26D239	Longlife+

### EHS Kit ▲ ■ ●

CODE	TECHNOLOGY
SCE21339	EHS
SCE22339	EHS
SCE23339	EHS
SC24339	Longlife+
SC25339	Longlife+
SC26339	Longlife+

### EHS Kit ▲ ■ ●

POS.	CODE	TECHNOLOGY
1	SCE21005	EHS
2	SCE22005	EHS
3	SCE23005	EHS
4	SC24005	Longlife+
5	SC25005	Longlife+
6	SC26005	Longlife+

### EHS Kit ▲ ■ ●

CODE	TECHNOLOGY
SCE21012	EHS
SCE22012	EHS
SCE23012	EHS
SC24012	Longlife+
SC25012	Longlife+
SC26012	Longlife+

### EHS Kit ▲ ■ ●

CODE	TECHNOLOGY
SCE21D521	EHS
SCE22D521	EHS
SCE23D521	EHS
SC24D521	Longlife+
SC25D521	Longlife+
SC26D521	Longlife+

### Standard Kit ▲ ■ ●

POS.	CODE	TECHNOLOGY
1	SC21011	Zenith
2	SC22011	Zenith
3	SC23011	BiPower
3X	SC2X011	XtraFine
4	SC24011	Longlife+
5	SC25011	Longlife+
6	SC26011	Longlife+

### Standard Kit ▲ ■ ●

CODE	TECHNOLOGY
SC21D239	Zenith
SC22D239	Zenith
SC23D239	BiPower
SC2XD239	XtraFine
SC24D239	Longlife+
SC25D239	Longlife+
SC26D239	Longlife+

### Standard Kit ▲ ■ ●

CODE	TECHNOLOGY
SC21339	Zenith
SC22339	Zenith
SC23339	BiPower
SC2X339	XtraFine
SC24339	Longlife+
SC25339	Longlife+
SC26339	Longlife+

### Standard Kit ▲ ■ ●

POS.	CODE	TECHNOLOGY
1	SC21005	Zenith
2	SC22005	Zenith
3	SC23005	BiPower
3X	SC2X005	XtraFine
4	SC24005	Longlife+
5	SC25005	Longlife+
6	SC26005	Longlife+

### Standard Kit ▲ ■ ●

CODE	TECHNOLOGY
SC21012	Zenith
SC22012	Zenith
SC23012	BiPower
SC2X012	XtraFine
SC24012	Longlife+
SC25012	Longlife+
SC26012	Longlife+

### Standard Kit ▲ ■ ●

CODE	TECHNOLOGY
SC21D521	Zenith
SC22D521	Zenith
SC23D521	BiPower
SC2XD521	XtraFine
SC24D521	Longlife+
SC25D521	Longlife+
SC26D521	Longlife+

### Electroplated Kit ●

POS.	CODE	TECHNOLOGY
1	SC27011	Electroplated
2	SC28011	Electroplated
3	SC23011	BiPower
4	SC24011	Longlife+
5	SC25011	Longlife+
6	SC26011	Longlife+

### Electroplated Kit ●

CODE	TECHNOLOGY
SC27D239	Electroplated
SC28D239	Electroplated
SC23D239	BiPower
SC24D239	Longlife+
SC25D239	Longlife+
SC26D239	Longlife+

### Electroplated Kit ●

CODE	TECHNOLOGY
SC27339	Electroplated
SC28339	Electroplated
SC23339	BiPower
SC24339	Longlife+
SC25339	Longlife+
SC26339	Longlife+

### Electroplated Kit ●

POS.	CODE	TECHNOLOGY
1	SC27005	Electroplated
2	SC28005	Electroplated
3	SC23005	BiPower
4	SC24005	Longlife+
5	SC25005	Longlife+
6	SC26005	Longlife+

### Electroplated Kit ●

CODE	TECHNOLOGY
SC27012	Electroplated
SC28012	Electroplated
SC23012	BiPower
SC24012	Longlife+
SC25012	Longlife+
SC26012	Longlife+

### Electroplated Kit ●

CODE	TECHNOLOGY
SC27D521	Electroplated
SC28D521	Electroplated
SC23D521	BiPower
SC24D521	Longlife+
SC25D521	Longlife+
SC26D521	Longlife+



## A30 r5 Pfd DEC

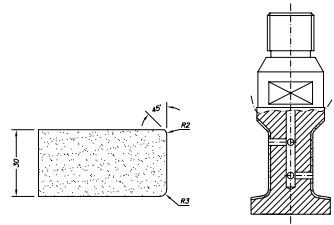

## A30 r6

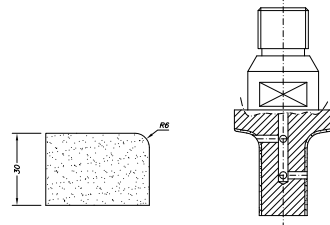

## A30 r6 Pfd

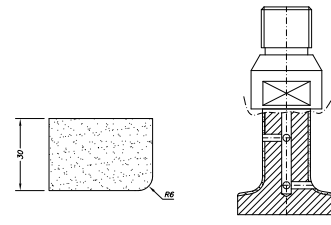

## A40 r3 Pfd

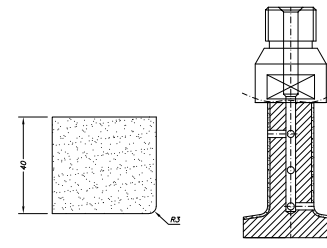

## A40 r5

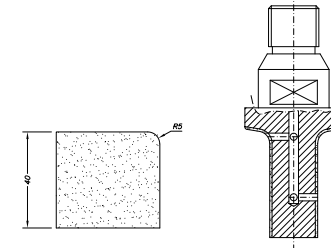

## A40 r5 Pfd

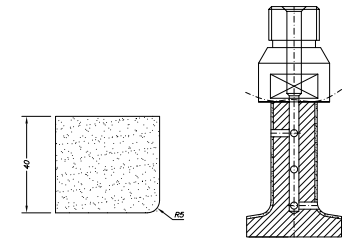

### EHS Kit ▲ ■ ●

POS.	CODE	TECHNOLOGY
1	SCE21199	EHS
2	SCE22199	EHS
3	SCE23199	EHS
4	SC24199	Longlife+
5	SC25199	Longlife+
6	SC26199	Longlife+

### EHS Kit ▲ ■ ●

CODE	TECHNOLOGY
SCE21006	EHS
SCE22006	EHS
SCE23006	EHS
SC24006	Longlife+
SC25006	Longlife+
SC26006	Longlife+

### EHS Kit ▲ ■ ●

CODE	TECHNOLOGY
SCE21013	EHS
SCE22013	EHS
SCE23013	EHS
SC24013	Longlife+
SC25013	Longlife+
SC26013	Longlife+

### EHS Kit ▲ ■ ●

POS.	CODE	TECHNOLOGY
1	SCE21245	EHS
2	SCE22245	EHS
3	SCE23245	EHS
4	SC24245	Longlife+
5	SC25245	Longlife+
6	SC26245	Longlife+

### EHS Kit ▲ ■ ●

CODE	TECHNOLOGY
SCE21240	EHS
SCE22240	EHS
SCE23240	EHS
SC24240	Longlife+
SC25240	Longlife+
SC26240	Longlife+

### EHS Kit ▲ ■ ●

CODE	TECHNOLOGY
SCE21342	EHS
SCE22342	EHS
SCE23342	EHS
SC24342	Longlife+
SC25342	Longlife+
SC26342	Longlife+

### Standard Kit ▲ ■ ●

POS.	CODE	TECHNOLOGY
1	SC21199	Zenith
2	SC22199	Zenith
3	SC23199	BiPower
3X	SC2X199	XtraFine
4	SC24199	Longlife+
5	SC25199	Longlife+
6	SC26199	Longlife+

### Standard Kit ▲ ■ ●

CODE	TECHNOLOGY
SC21006	Zenith
SC22006	Zenith
SC23006	BiPower
SC2X006	XtraFine
SC24006	Longlife+
SC25006	Longlife+
SC26006	Longlife+

### Standard Kit ▲ ■ ●

CODE	TECHNOLOGY
SC21013	Zenith
SC22013	Zenith
SC23013	BiPower
SC2X013	XtraFine
SC24013	Longlife+
SC25013	Longlife+
SC26013	Longlife+

### Standard Kit ▲ ■ ●

POS.	CODE	TECHNOLOGY
1	SC21245	Zenith
2	SC22245	Zenith
3	SC23245	BiPower
3X	SC2X245	XtraFine
4	SC24245	Longlife+
5	SC25245	Longlife+
6	SC26245	Longlife+

### Standard Kit ▲ ■ ●

CODE	TECHNOLOGY
SC21240	Zenith
SC22240	Zenith
SC23240	BiPower
SC2X240	XtraFine
SC24240	Longlife+
SC25240	Longlife+
SC26240	Longlife+

### Standard Kit ▲ ■ ●

CODE	TECHNOLOGY
SC21342	Zenith
SC22342	Zenith
SC23342	BiPower
SC2X342	XtraFine
SC24342	Longlife+
SC25342	Longlife+
SC26342	Longlife+

### Electroplated Kit ●

POS.	CODE	TECHNOLOGY
1	SC27199	Electroplated
2	SC28199	Electroplated
3	SC23199	BiPower
4	SC24199	Longlife+
5	SC25199	Longlife+
6	SC26199	Longlife+

### Electroplated Kit ●

CODE	TECHNOLOGY
SC27006	Electroplated
SC28006	Electroplated
SC23006	BiPower
SC24006	Longlife+
SC25006	Longlife+
SC26006	Longlife+

### Electroplated Kit ●

CODE	TECHNOLOGY
SC27013	Electroplated
SC28013	Electroplated
SC23013	BiPower
SC24013	Longlife+
SC25013	Longlife+
SC26013	Longlife+

### Electroplated Kit ●

POS.	CODE	TECHNOLOGY
1	SC27245	Electroplated
2	SC28245	Electroplated
3	SC23245	BiPower
4	SC24245	Longlife+
5	SC25245	Longlife+
6	SC26245	Longlife+

### Electroplated Kit ●

CODE	TECHNOLOGY
SC27240	Electroplated
SC28240	Electroplated
SC23240	BiPower
SC24240	Longlife+
SC25240	Longlife+
SC26240	Longlife+

### Electroplated Kit ●

CODE	TECHNOLOGY
SC27342	Electroplated
SC28342	Electroplated
SC23342	BiPower
SC24342	Longlife+
SC25342	Longlife+
SC26342	Longlife+



## T12 r2.5

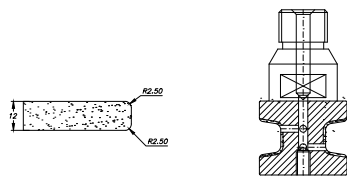

## T12 r5

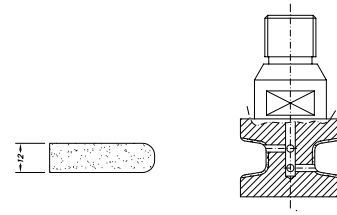

## T20 r3

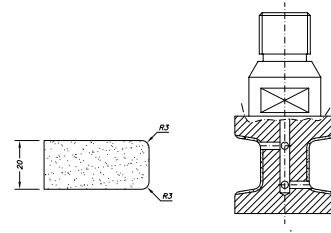

## T20 r5

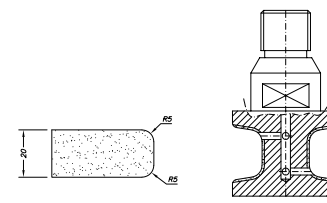

## T30 r3

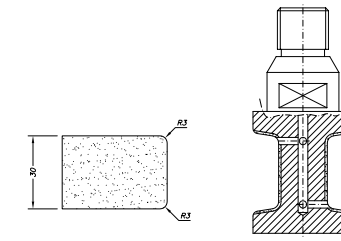

## T30 r4

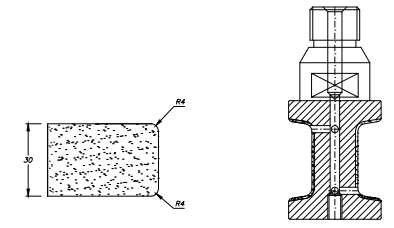

### EHS Kit ▲ ■ ●

POS.	CODE	TECHNOLOGY
1	SCE21D168	EHS
2	SCE22D168	EHS
3	SCE23D168	EHS
4	SC24D168	Longlife+
5	SC25D168	Longlife+
6	SC26D168	Longlife+

### EHS Kit ▲ ■ ●

POS.	CODE	TECHNOLOGY
1	SCE21243	EHS
2	SCE22243	EHS
3	SCE23243	EHS
4	SC24243	Longlife+
5	SC25243	Longlife+
6	SC26243	Longlife+

### EHS Kit ▲ ■ ●

POS.	CODE	TECHNOLOGY
1	SCE21114	EHS
2	SCE22114	EHS
3	SCE23114	EHS
4	SC24114	Longlife+
5	SC25114	Longlife+
6	SC26114	Longlife+

### EHS Kit ▲ ■ ●

POS.	CODE	TECHNOLOGY
1	SCE21080	EHS
2	SCE22080	EHS
3	SCE23080	EHS
4	SC24080	Longlife+
5	SC25080	Longlife+
6	SC26080	Longlife+

### EHS Kit ▲ ■ ●

POS.	CODE	TECHNOLOGY
1	SCE21115	EHS
2	SCE22115	EHS
3	SCE23115	EHS
4	SC24115	Longlife+
5	SC25115	Longlife+
6	SC26115	Longlife+

### EHS Kit ▲ ■ ●

POS.	CODE	TECHNOLOGY
1	SCE21444	EHS
2	SCE22444	EHS
3	SCE23444	EHS
4	SC24444	Longlife+
5	SC25444	Longlife+
6	SC26444	Longlife+

### Standard Kit ▲ ■ ●

POS.	CODE	TECHNOLOGY
1	SC21D168	Zenith
2	SC22D168	Zenith
3	SC23D168	BiPower
3X	SC2XD168	XtraFine
4	SC24D168	Longlife+
5	SC25D168	Longlife+
6	SC26D168	Longlife+

### Standard Kit ▲ ■ ●

POS.	CODE	TECHNOLOGY
1	SC21243	Zenith
2	SC22243	Zenith
3	SC23243	BiPower
3X	SC2X243	XtraFine
4	SC24243	Longlife+
5	SC25243	Longlife+
6	SC26243	Longlife+

### Standard Kit ▲ ■ ●

POS.	CODE	TECHNOLOGY
1	SC21114	Zenith
2	SC22114	Zenith
3	SC23114	BiPower
3X	SC2X114	XtraFine
4	SC24114	Longlife+
5	SC25114	Longlife+
6	SC26114	Longlife+

### Standard Kit ▲ ■ ●

POS.	CODE	TECHNOLOGY
1	SC21080	Zenith
2	SC22080	Zenith
3	SC23080	BiPower
3X	SC2X080	XtraFine
4	SC24080	Longlife+
5	SC25080	Longlife+
6	SC26080	Longlife+

### Standard Kit ▲ ■ ●

POS.	CODE	TECHNOLOGY
1	SC21115	Zenith
2	SC22115	Zenith
3	SC23115	BiPower
3X	SC2X115	XtraFine
4	SC24115	Longlife+
5	SC25115	Longlife+
6	SC26115	Longlife+

### Standard Kit ▲ ■ ●

POS.	CODE	TECHNOLOGY
1	SC21444	Zenith
2	SC22444	Zenith
3	SC23444	BiPower
3X	SC2X444	XtraFine
4	SC24444	Longlife+
5	SC25444	Longlife+
6	SC26444	Longlife+

### Electroplated Kit ●

POS.	CODE	TECHNOLOGY
1	SC27D168	Electroplated
2	SC28D168	Electroplated
3	SC23D168	BiPower
4	SC24D168	Longlife+
5	SC25D168	Longlife+
6	SC26D168	Longlife+

### Electroplated Kit ●

POS.	CODE	TECHNOLOGY
1	SC27243	Electroplated
2	SC28243	Electroplated
3	SC23243	BiPower
4	SC24243	Longlife+
5	SC25243	Longlife+
6	SC26243	Longlife+

### Electroplated Kit ●

POS.	CODE	TECHNOLOGY
1	SC27114	Electroplated
2	SC28114	Electroplated
3	SC23114	BiPower
4	SC24114	Longlife+
5	SC25114	Longlife+
6	SC26114	Longlife+

### Electroplated Kit ●

POS.	CODE	TECHNOLOGY
1	SC27080	Electroplated
2	SC28080	Electroplated
3	SC23080	BiPower
4	SC24080	Longlife+
5	SC25080	Longlife+
6	SC26080	Longlife+

### Electroplated Kit ●

POS.	CODE	TECHNOLOGY
1	SC27115	Electroplated
2	SC28115	Electroplated
3	SC23115	BiPower
4	SC24115	Longlife+
5	SC25115	Longlife+
6	SC26115	Longlife+

### Electroplated Kit ●

POS.	CODE	TECHNOLOGY
1	SC27444	Electroplated
2	SC28444	Electroplated
3	SC23444	BiPower
4	SC24444	Longlife+
5	SC25444	Longlife+
6	SC26444	Longlife+

### Glossforce3.0

POS.	CODE	TECHNOLOGY
4	SCG24115	GlossForce 3.0
5	SCG25115	GlossForce 3.0
6	SCG26115	GlossForce 3.0



### T30 r5

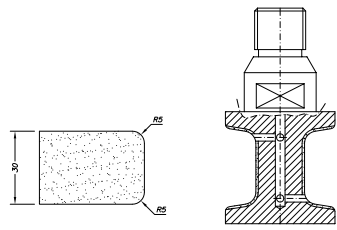

### T30 r6

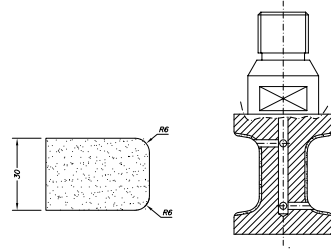

### T30 r8

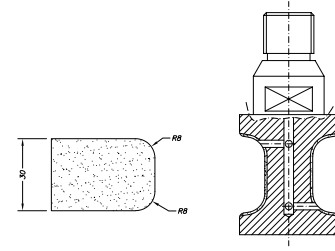

### T32 r3

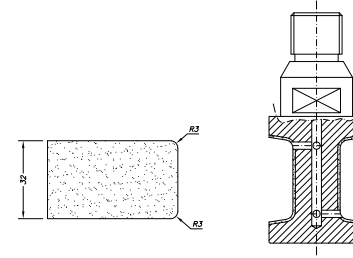

### T40 r3.5

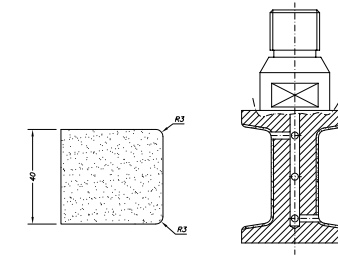

### T40 r5

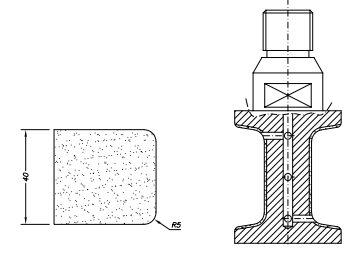

#### EHS Kit ▲ ■ ●

POS.	CODE	TECHNOLOGY
1	SCE21082	EHS
2	SCE22082	EHS
3	SCE23082	EHS
4	SC24082	Longlife+
5	SC25082	Longlife+
6	SC26082	Longlife+

#### EHS Kit ▲ ■ ●

POS.	CODE	TECHNOLOGY
1	SCE21D156	EHS
2	SCE22D156	EHS
3	SCE23D156	EHS
4	SC24D156	Longlife+
5	SC25D156	Longlife+
6	SC26D156	Longlife+

#### EHS Kit ▲ ■ ●

POS.	CODE	TECHNOLOGY
1	SCE21D096	EHS
2	SCE22D096	EHS
3	SCE23D096	EHS
4	SC24D096	Longlife+
5	SC25D096	Longlife+
6	SC26D096	Longlife+

#### EHS Kit ▲ ■ ●

POS.	CODE	TECHNOLOGY
1	SCE21D017	EHS
2	SCE22D017	EHS
3	SCE23D017	EHS
4	SC24D017	Longlife+
5	SC25D017	Longlife+
6	SC26D017	Longlife+

#### EHS Kit ▲ ■ ●

POS.	CODE	TECHNOLOGY
1	SCE21117	EHS
2	SCE22117	EHS
3	SCE23117	EHS
4	SC24117	Longlife+
5	SC25117	Longlife+
6	SC26117	Longlife+

#### EHS Kit ▲ ■ ●

POS.	CODE	TECHNOLOGY
1	SCE21084	EHS
2	SCE22084	EHS
3	SCE23084	EHS
4	SC24084	Longlife+
5	SC25084	Longlife+
6	SC26084	Longlife+

#### Standard Kit ▲ ■ ●

POS.	CODE	TECHNOLOGY
1	SC21082	Zenith
2	SC22082	Zenith
3	SC23082	BiPower
3X	SC2X082	XtraFine
4	SC24082	Longlife+
5	SC25082	Longlife+
6	SC26082	Longlife+

#### Standard Kit ▲ ■ ●

POS.	CODE	TECHNOLOGY
1	SC21D156	Zenith
2	SC22D156	Zenith
3	SC23D156	BiPower
3X	SC2XD156	XtraFine
4	SC24D156	Longlife+
5	SC25D156	Longlife+
6	SC26D156	Longlife+

#### Standard Kit ▲ ■ ●

POS.	CODE	TECHNOLOGY
1	SC21D096	Zenith
2	SC22D096	Zenith
3	SC23D096	BiPower
3X	SC2XD096	XtraFine
4	SC24D096	Longlife+
5	SC25D096	Longlife+
6	SC26D096	Longlife+

#### Standard Kit ▲ ■ ●

POS.	CODE	TECHNOLOGY
1	SC21D017	Zenith
2	SC22D017	Zenith
3	SC23D017	BiPower
3X	SC2XD017	XtraFine
4	SC24D017	Longlife+
5	SC25D017	Longlife+
6	SC26D017	Longlife+

#### Standard Kit ▲ ■ ●

POS.	CODE	TECHNOLOGY
1	SC21117	Zenith
2	SC22117	Zenith
3	SC23117	BiPower
3X	SC2X117	XtraFine
4	SC24117	Longlife+
5	SC25117	Longlife+
6	SC26117	Longlife+

#### Standard Kit ▲ ■ ●

POS.	CODE	TECHNOLOGY
1	SC21084	Zenith
2	SC22084	Zenith
3	SC23084	BiPower
3X	SC2X084	XtraFine
4	SC24084	Longlife+
5	SC25084	Longlife+
6	SC26084	Longlife+

#### Electroplated Kit ●

POS.	CODE	TECHNOLOGY
1	SC27082	Electroplated
2	SC28082	Electroplated
3	SC23082	BiPower
4	SC24082	Longlife+
5	SC25082	Longlife+
6	SC26082	Longlife+

#### Electroplated Kit ●

POS.	CODE	TECHNOLOGY
1	SC27D156	Electroplated
2	SC28D156	Electroplated
3	SC23D156	BiPower
4	SC24D156	Longlife+
5	SC25D156	Longlife+
6	SC26D156	Longlife+

#### Electroplated Kit ●

POS.	CODE	TECHNOLOGY
1	SC27D096	Electroplated
2	SC28D096	Electroplated
3	SC23D096	BiPower
4	SC24D096	Longlife+
5	SC25D096	Longlife+
6	SC26D096	Longlife+

#### Electroplated Kit ●

POS.	CODE	TECHNOLOGY
1	SC27D017	Electroplated
2	SC28D017	Electroplated
3	SC23D017	BiPower
4	SC24D017	Longlife+
5	SC25D017	Longlife+
6	SC26D017	Longlife+

#### Electroplated Kit ●

POS.	CODE	TECHNOLOGY
1	SC27117	Electroplated
2	SC28117	Electroplated
3	SC23117	BiPower
4	SC24117	Longlife+
5	SC25117	Longlife+
6	SC26117	Longlife+

#### Electroplated Kit ●

POS.	CODE	TECHNOLOGY
1	SC27084	Electroplated
2	SC28084	Electroplated
3	SC23084	BiPower
4	SC24084	Longlife+
5	SC25084	Longlife+
6	SC26084	Longlife+





## X+D12

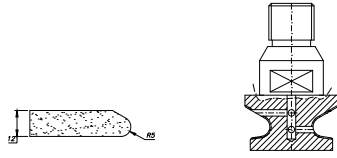

## YS12 1.5x1.5

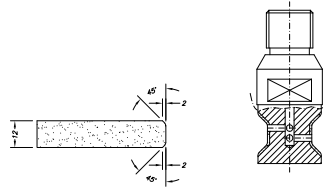

## YS20 1.5x1.5

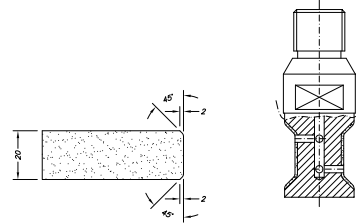

## YS20 2x2

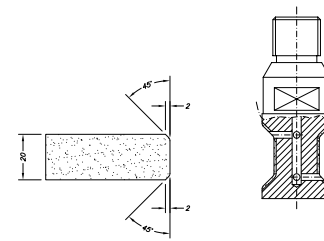

## YS20 3x3

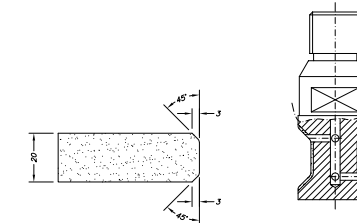

## YS30 1.5x1.5

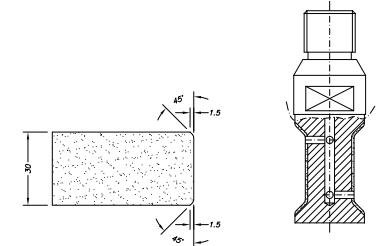

### EHS Kit ▲ ■ ●

POS.	CODE	TECHNOLOGY
1	SCE21110	EHS
2	SCE22110	EHS
3	SCE23110	EHS
4	SC24110	Longlife+
5	SC25110	Longlife+
6	SC26110	Longlife+

### EHS Kit ▲ ■ ●

POS.	CODE	TECHNOLOGY
1	SCE21D191	EHS
2	SCE22D191	EHS
3	SCE23D191	EHS
4	SC24D191	Longlife+
5	SC25D191	Longlife+
6	SC26D191	Longlife+

### EHS Kit ▲ ■ ●

POS.	CODE	TECHNOLOGY
1	SCE21D028	EHS
2	SCE22D028	EHS
3	SCE23D028	EHS
4	SC24D028	Longlife+
5	SC25D028	Longlife+
6	SC26D028	Longlife+

### EHS Kit ▲ ■ ●

POS.	CODE	TECHNOLOGY
1	SCE21D283	EHS
2	SCE22D283	EHS
3	SCE23D283	EHS
4	SC24D283	Longlife+
5	SC25D283	Longlife+
6	SC26D283	Longlife+

### EHS Kit ▲ ■ ●

POS.	CODE	TECHNOLOGY
1	SCE21120	EHS
2	SCE22120	EHS
3	SCE23120	EHS
4	SC24120	Longlife+
5	SC25120	Longlife+
6	SC26120	Longlife+

### EHS Kit ▲ ■ ●

POS.	CODE	TECHNOLOGY
1	SCE21D445	EHS
2	SCE22D445	EHS
3	SCE23D445	EHS
4	SC24D445	Longlife+
5	SC25D445	Longlife+
6	SC26D445	Longlife+

### Standard Kit ▲ ■ ●

POS.	CODE	TECHNOLOGY
1	SC21110	Zenith
2	SC22110	Zenith
3	SC23110	BiPower
3X	SC2X110	XtraFine
4	SC24110	Longlife+
5	SC25110	Longlife+
6	SC26110	Longlife+

### Standard Kit ▲ ■ ●

POS.	CODE	TECHNOLOGY
1	SC21D191	Zenith
2	SC22D191	Zenith
3	SC23D191	BiPower
3X	SC2XD191	XtraFine
4	SC24D191	Longlife+
5	SC25D191	Longlife+
6	SC26D191	Longlife+

### Standard Kit ▲ ■ ●

POS.	CODE	TECHNOLOGY
1	SC21D028	Zenith
2	SC22D028	Zenith
3	SC23D028	BiPower
3X	SC2XD028	XtraFine
4	SC24D028	Longlife+
5	SC25D028	Longlife+
6	SC26D028	Longlife+

### Standard Kit ▲ ■ ●

POS.	CODE	TECHNOLOGY
1	SC21D283	Zenith
2	SC22D283	Zenith
3	SC23D283	BiPower
3X	SC2XD283	XtraFine
4	SC24D283	Longlife+
5	SC25D283	Longlife+
6	SC26D283	Longlife+

### Standard Kit ▲ ■ ●

POS.	CODE	TECHNOLOGY
1	SC21120	Zenith
2	SC22120	Zenith
3	SC23120	BiPower
3X	SC2X120	XtraFine
4	SC24120	Longlife+
5	SC25120	Longlife+
6	SC26120	Longlife+

### Standard Kit ▲ ■ ●

POS.	CODE	TECHNOLOGY
1	SC21D445	Zenith
2	SC22D445	Zenith
3	SC23D445	BiPower
3X	SC2XD445	XtraFine
4	SC24D445	Longlife+
5	SC25D445	Longlife+
6	SC26D445	Longlife+

### Electroplated Kit ●

POS.	CODE	TECHNOLOGY
1	SC27110	Electroplated
2	SC28110	Electroplated
3	SC23110	BiPower
4	SC24110	Longlife+
5	SC25110	Longlife+
6	SC26110	Longlife+

### Electroplated Kit ●

POS.	CODE	TECHNOLOGY
1	SC27D191	Electroplated
2	SC28D191	Electroplated
3	SC23D191	BiPower
4	SC24D191	Longlife+
5	SC25D191	Longlife+
6	SC26D191	Longlife+

### Electroplated Kit ●

POS.	CODE	TECHNOLOGY
1	SC27D028	Electroplated
2	SC28D028	Electroplated
3	SC23D028	BiPower
4	SC24D028	Longlife+
5	SC25D028	Longlife+
6	SC26D028	Longlife+

### Electroplated Kit ●

POS.	CODE	TECHNOLOGY
1	SC27D283	Electroplated
2	SC28D283	Electroplated
3	SC23D283	BiPower
4	SC24D283	Longlife+
5	SC25D283	Longlife+
6	SC26D283	Longlife+

### Electroplated Kit ●

POS.	CODE	TECHNOLOGY
1	SC27120	Electroplated
2	SC28120	Electroplated
3	SC23120	BiPower
4	SC24120	Longlife+
5	SC25120	Longlife+
6	SC26120	Longlife+

### Electroplated Kit ●

POS.	CODE	TECHNOLOGY
1	SC27D445	Electroplated
2	SC28D445	Electroplated
3	SC23D445	BiPower
4	SC24D445	Longlife+
5	SC25D445	Longlife+
6	SC26D445	Longlife+



## YS30 2x2

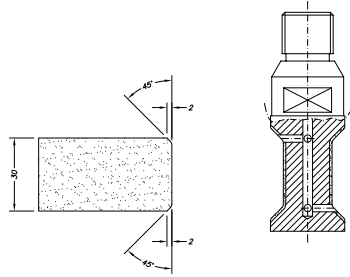

## YS30 3x3

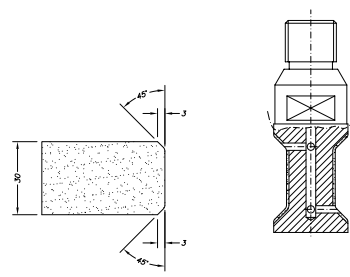

## YS40 3x3

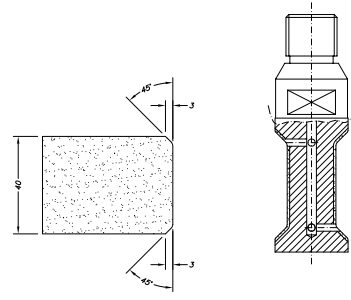

## Z20

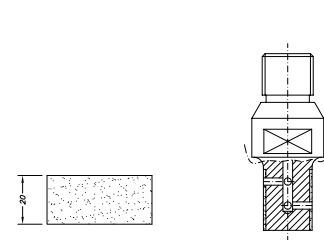

## Z30

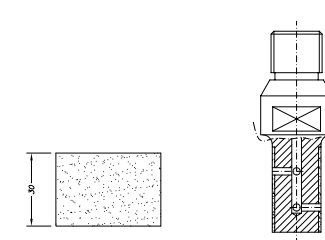

## Z40

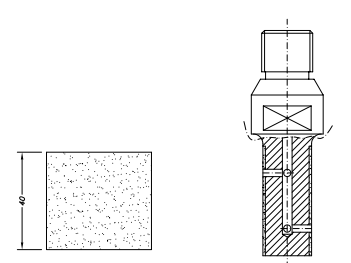

### EHS Kit ▲ ■ ●

POS.	CODE	TECHNOLOGY
1	SCE21122	EHS
2	SCE22122	EHS
3	SCE23122	EHS
4	SC24122	Longlife+
5	SC25122	Longlife+
6	SC26122	Longlife+

### EHS Kit ▲ ■ ●

POS.	CODE	TECHNOLOGY
1	SCE21121	EHS
2	SCE22121	EHS
3	SCE23121	EHS
4	SC24121	Longlife+
5	SC25121	Longlife+
6	SC26121	Longlife+

### EHS Kit ▲ ■ ●

POS.	CODE	TECHNOLOGY
1	SCE21124	EHS
2	SCE22124	EHS
3	SCE23124	EHS
4	SC24124	Longlife+
5	SC25124	Longlife+
6	SC26124	Longlife+

### EHS Kit ▲ ■ ●

POS.	CODE	TECHNOLOGY
1	SC21033	EHS
2	SC22033	EHS
3	SC23033	EHS
4	SC24033	Longlife+
5	SC25033	Longlife+
6	SC26033	Longlife+

### EHS Kit ▲ ■ ●

POS.	CODE	TECHNOLOGY
1	SCE21034	EHS
2	SCE22034	EHS
3	SCE23034	EHS
4	SC24034	Longlife+
5	SC25034	Longlife+
6	SC26034	Longlife+

### EHS Kit ▲ ■ ●

POS.	CODE	TECHNOLOGY
1	SCE21035	EHS
2	SCE22035	EHS
3	SCE23035	EHS
4	SC24035	Longlife+
5	SC25035	Longlife+
6	SC26035	Longlife+

### Standard Kit ▲ ■ ●

POS.	CODE	TECHNOLOGY
1	SC21122	Zenith
2	SC22122	Zenith
3	SC23122	BiPower
3X	SC2X122	XtraFine
4	SC24122	Longlife+
5	SC25122	Longlife+
6	SC26122	Longlife+

### Standard Kit ▲ ■ ●

POS.	CODE	TECHNOLOGY
1	SC21121	Zenith
2	SC22121	Zenith
3	SC23121	BiPower
3X	SC2X121	XtraFine
4	SC24121	Longlife+
5	SC25121	Longlife+
6	SC26121	Longlife+

### Standard Kit ▲ ■ ●

POS.	CODE	TECHNOLOGY
1	SC21124	Zenith
2	SC22124	Zenith
3	SC23124	BiPower
3X	SC2X124	XtraFine
4	SC24124	Longlife+
5	SC25124	Longlife+
6	SC26124	Longlife+

### Standard Kit ▲ ■ ●

POS.	CODE	TECHNOLOGY
1	SC21033	Zenith
2	SC22033	Zenith
3	SC23033	BiPower
3X	SC2X033	XtraFine
4	SC24033	Longlife+
5	SC25033	Longlife+
6	SC26033	Longlife+

### Standard Kit ▲ ■ ●

POS.	CODE	TECHNOLOGY
1	SC21034	Zenith
2	SC22034	Zenith
3	SC23034	BiPower
3X	SC2X034	XtraFine
4	SC24034	Longlife+
5	SC25034	Longlife+
6	SC26034	Longlife+

### Standard Kit ▲ ■ ●

POS.	CODE	TECHNOLOGY
1	SC21035	Zenith
2	SC22035	Zenith
3	SC23035	BiPower
3X	SC2X035	XtraFine
4	SC24035	Longlife+
5	SC25035	Longlife+
6	SC26035	Longlife+

### Electroplated Kit ●

POS.	CODE	TECHNOLOGY
1	SC27122	Electroplated
2	SC28122	Electroplated
3	SC23122	BiPower
4	SC24122	Longlife+
5	SC25122	Longlife+
6	SC26122	Longlife+

### Electroplated Kit ●

POS.	CODE	TECHNOLOGY
1	SC27121	Electroplated
2	SC28121	Electroplated
3	SC23121	BiPower
4	SC24121	Longlife+
5	SC25121	Longlife+
6	SC26121	Longlife+

### Electroplated Kit ●

POS.	CODE	TECHNOLOGY
1	SC27124	Electroplated
2	SC28124	Electroplated
3	SC23124	BiPower
4	SC24124	Longlife+
5	SC25124	Longlife+
6	SC26124	Longlife+

### Electroplated Kit ●

POS.	CODE	TECHNOLOGY
1	SC27033	Electroplated
2	SC28033	Electroplated
3	SC23033	BiPower
4	SC24033	Longlife+
5	SC25033	Longlife+
6	SC26033	Longlife+

### Electroplated Kit ●

POS.	CODE	TECHNOLOGY
1	SC27034	Electroplated
2	SC28034	Electroplated
3	SC23034	BiPower
4	SC24034	Longlife+
5	SC25034	Longlife+
6	SC26034	Longlife+

### Electroplated Kit ●

POS.	CODE	TECHNOLOGY
1	SC27035	Electroplated
2	SC28035	Electroplated
3	SC23035	BiPower
4	SC24035	Longlife+
5	SC25035	Longlife+
6	SC26035	Longlife+



## Z50

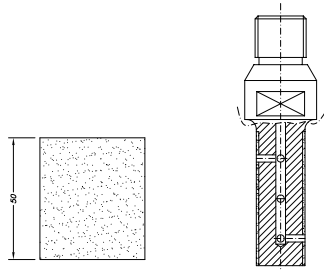

## ZS30

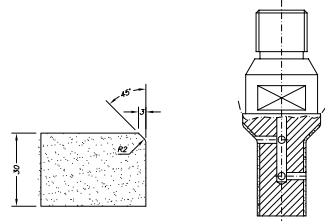

## ZS30 Pfd

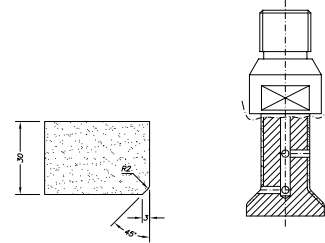

## ZS40

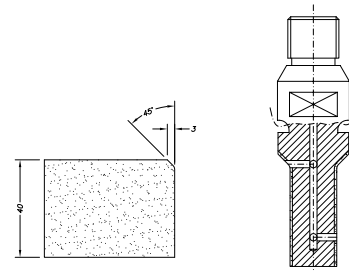

## ZS40 Pfd

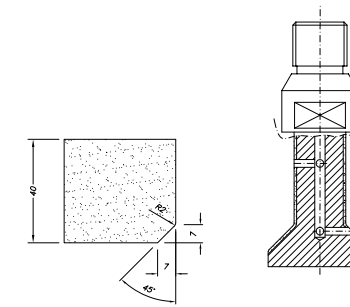

### EHS Kit ▲ ■ ●

POS.	CODE	TECHNOLOGY
1	SCE21036	EHS
2	SCE22036	EHS
3	SCE23036	EHS
4	SC24036	Longlife+
5	SC25036	Longlife+
6	SC26036	Longlife+

### EHS Kit ▲ ■ ●

POS.	CODE	TECHNOLOGY
1	SCE21041	EHS
2	SCE22041	EHS
3	SCE23041	EHS
4	SC24041	Longlife+
5	SC25041	Longlife+
6	SC26041	Longlife+

### EHS Kit ▲ ■ ●

POS.	CODE	TECHNOLOGY
1	SCE21043	EHS
2	SCE22043	EHS
3	SCE23043	EHS
4	SC24043	Longlife+
5	SC25043	Longlife+
6	SC26043	Longlife+

### EHS Kit ▲ ■ ●

POS.	CODE	TECHNOLOGY
1	SCE21042	EHS
2	SCE22042	EHS
3	SCE23042	EHS
4	SC24042	Longlife+
5	SC25042	Longlife+
6	SC26042	Longlife+

### EHS Kit ▲ ■ ●

POS.	CODE	TECHNOLOGY
1	SCE21044	EHS
2	SCE22044	EHS
3	SCE23044	EHS
4	SC24044	Longlife+
5	SC25044	Longlife+
6	SC26044	Longlife+

### Standard Kit ▲ ■ ●

POS.	CODE	TECHNOLOGY
1	SC21036	Zenith
2	SC22036	Zenith
3	SC23036	BiPower
3X	SC2X036	XtraFine
4	SC24036	Longlife+
5	SC25036	Longlife+
6	SC26036	Longlife+

### Standard Kit ▲ ■ ●

POS.	CODE	TECHNOLOGY
1	SC21041	Zenith
2	SC22041	Zenith
3	SC23041	BiPower
3X	SC2X041	XtraFine
4	SC24041	Longlife+
5	SC25041	Longlife+
6	SC26041	Longlife+

### Standard Kit ▲ ■ ●

POS.	CODE	TECHNOLOGY
1	SC21043	Zenith
2	SC22043	Zenith
3	SC23043	BiPower
3X	SC2X043	XtraFine
4	SC24043	Longlife+
5	SC25043	Longlife+
6	SC26043	Longlife+

### Standard Kit ▲ ■ ●

POS.	CODE	TECHNOLOGY
1	SC21042	Zenith
2	SC22042	Zenith
3	SC23042	BiPower
3X	SC2X042	XtraFine
4	SC24042	Longlife+
5	SC25042	Longlife+
6	SC26042	Longlife+

### Standard Kit ▲ ■ ●

POS.	CODE	TECHNOLOGY
1	SC21044	Zenith
2	SC22044	Zenith
3	SC23044	BiPower
3X	SC2X044	XtraFine
4	SC24044	Longlife+
5	SC25044	Longlife+
6	SC26044	Longlife+

### Electroplated Kit ●

POS.	CODE	TECHNOLOGY
1	SC27036	Electroplated
2	SC28036	Electroplated
3	SC23036	BiPower
4	SC24036	Longlife+
5	SC25036	Longlife+
6	SC26036	Longlife+

### Electroplated Kit ●

POS.	CODE	TECHNOLOGY
1	SC27041	Electroplated
2	SC28041	Electroplated
3	SC23041	BiPower
4	SC24041	Longlife+
5	SC25041	Longlife+
6	SC26041	Longlife+

### Electroplated Kit ●

POS.	CODE	TECHNOLOGY
1	SC27043	Electroplated
2	SC28043	Electroplated
3	SC23043	BiPower
4	SC24043	Longlife+
5	SC25043	Longlife+
6	SC26043	Longlife+

### Electroplated Kit ●

POS.	CODE	TECHNOLOGY
1	SC27042	Electroplated
2	SC28042	Electroplated
3	SC23042	BiPower
4	SC24042	Longlife+
5	SC25042	Longlife+
6	SC26042	Longlife+

### Electroplated Kit ●

POS.	CODE	TECHNOLOGY
1	SC27044	Electroplated
2	SC28044	Electroplated
3	SC23044	BiPower
4	SC24044	Longlife+
5	SC25044	Longlife+
6	SC26044	Longlife+

### Glossforce3.0

POS.	CODE	TECHNOLOGY
4	SCG24036	GlossForce 3.0
5	SCG25036	GlossForce 3.0
6	SCG26036	GlossForce 3.0

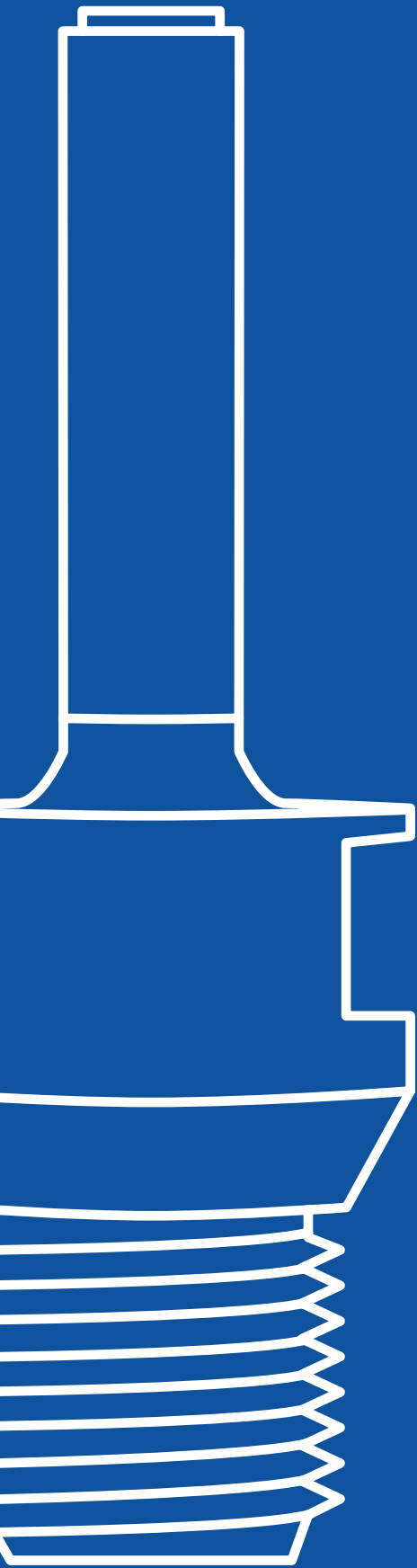

Elevate your sinkhole detailing with Line 10. Specifically designed for internal sinkhole profiling and polishing, Line 10 features a 10mm diameter, creating a refined 5mm radius. Choose from Standard and Electroplated technologies, catering to diverse needs. Seamlessly integrate using a 22mm bore fitting. Achieve impeccable sinkhole edges with Line 10's specialized composition.

Unleash creativity. We welcome custom profiles, fitting tweaks, and Electroplated technology. Elevate your CNC experience with tailored precision.

# Line 10



0

Pre-cutting



**SEGMENTED**  
For granite, ceramic and quartz

**Standard Kit**  
Universal



**Electroplated Kit**  
Marble



# Position



**1**

Profiling

**2**

Profiling

**3**

Profiling

**4**

Polishing

**5**

Polishing

**6**

Polishing

Standard Kit



**ZENITH**  
Universal



**BIPOWER**  
Universal



**LONGLIFE+**  
Universal



Electroplated Kit



**ELECTROPLATED**  
Marble







# Line 10 Profiles

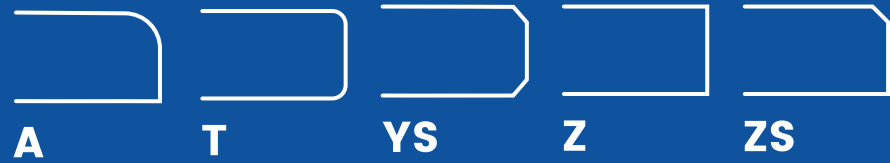

\* Custom designed profiles are accepted

## A30 r3

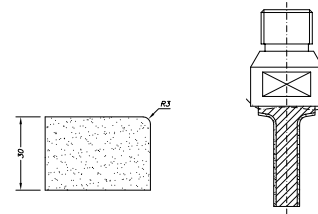

## A30 r3 Pfd

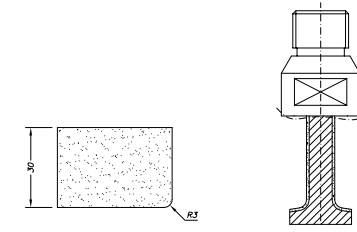

## T20 r3

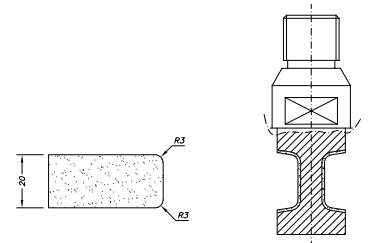

### Standard Kit ▲ ■ ●

POS.	CODE	TECHNOLOGY
0	SC21152	Segmented
1	SC21264	Zenith
2	SC22264	Zenith
3	SC23264	BiPower
3X	SC2X264	XtraFine
4	SC24264	Longlife+
5	SC25264	Longlife+
6	SC26264	Longlife+

### Standard Kit ▲ ■ ●

CODE	TECHNOLOGY
SC21152	Segmented
SC21364	Zenith
SC22364	Zenith
SC23364	BiPower
SC2X364	XtraFine
SC24364	Longlife+
SC25364	Longlife+
SC26364	Longlife+

### Standard Kit ▲ ■ ●

CODE	TECHNOLOGY
SC21152	Segmented
SC21355	Zenith
SC22355	Zenith
SC23355	BiPower
SC2X355	XtraFine
SC24355	Longlife+
SC25355	Longlife+
SC26355	Longlife+

### Electroplated Kit ●

POS.	CODE	TECHNOLOGY
1	SC27264	Electroplated
2	SC28264	Electroplated
3	SC23264	BiPower
4	SC24264	Longlife+
5	SC25264	Longlife+
6	SC26264	Longlife+

### Electroplated Kit ●

CODE	TECHNOLOGY
SC27364	Electroplated
SC28364	Electroplated
SC23364	BiPower
SC24364	Longlife+
SC25364	Longlife+
SC26364	Longlife+

### Electroplated Kit ●

CODE	TECHNOLOGY
SC27355	Electroplated
SC28355	Electroplated
SC23355	BiPower
SC24355	Longlife+
SC25355	Longlife+
SC26355	Longlife+



### T30 r3

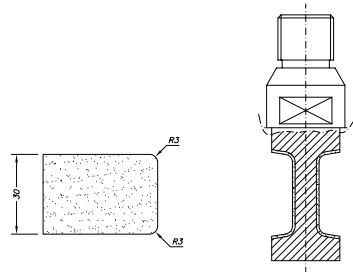

### YS20 1.5x1.5

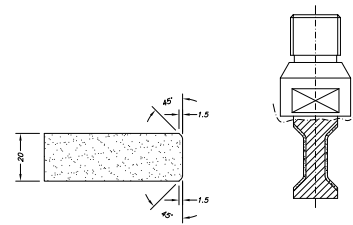

### YS30 1.5x1.5

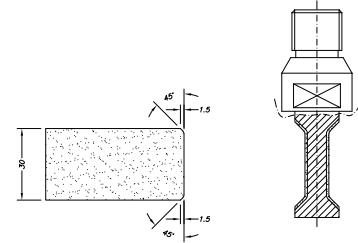

### Z30

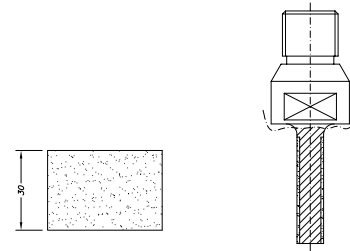

### ZS30

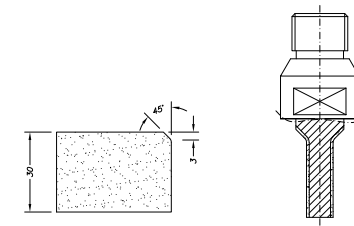

### ZS30 Pfd

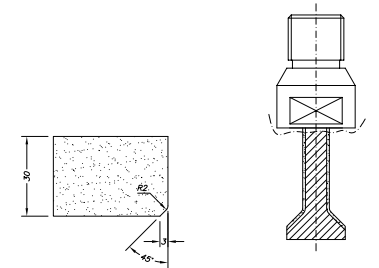

#### Standard Kit ▲ ■ ●

POS.	CODE	TECHNOLOGY
0	SC21152	Segmented
1	SC21455	Zenith
2	SC22455	Zenith
3	SC23455	BiPower
3X	SC2X455	XtraFine
4	SC24455	Longlife+
5	SC25455	Longlife+
6	SC26455	Longlife+

#### Standard Kit ▲ ■ ●

CODE	TECHNOLOGY
SC21152	Segmented
SC21555	Zenith
SC22555	Zenith
SC23555	BiPower
SC2X555	XtraFine
SC24555	Longlife+
SC25555	Longlife+
SC26555	Longlife+

#### Standard Kit ▲ ■ ●

CODE	TECHNOLOGY
SC21152	Segmented
SC21655	Zenith
SC22655	Zenith
SC23655	BiPower
SC2X655	XtraFine
SC24655	Longlife+
SC25655	Longlife+
SC26655	Longlife+

#### Standard Kit ▲ ■ ●

POS.	CODE	TECHNOLOGY
0	SC21152	Segmented
1	-	-
2	SC22255	Zenith
3	SC23255	BiPower
3X	SC2X255	XtraFine
4	SC24255	Longlife+
5	SC25255	Longlife+
6	SC26255	Longlife+

#### Standard Kit ▲ ■ ●

CODE	TECHNOLOGY
SC21152	Segmented
SC21260	Zenith
SC22260	Zenith
SC23260	BiPower
SC2X260	XtraFine
SC24260	Longlife+
SC25260	Longlife+
SC26260	Longlife+

#### Standard Kit ▲ ■ ●

CODE	TECHNOLOGY
SC21152	Segmented
SC21755	Zenith
SC22755	Zenith
SC23755	BiPower
SC2X755	XtraFine
SC24755	Longlife+
SC25755	Longlife+
SC26755	Longlife+

#### Electroplated Kit ●

POS.	CODE	TECHNOLOGY
1	SC27455	Electroplated
2	SC28455	Electroplated
3	SC23455	BiPower
4	SC24455	Longlife+
5	SC25455	Longlife+
6	SC26455	Longlife+

#### Electroplated Kit ●

CODE	TECHNOLOGY
SC27555	Electroplated
SC28555	Electroplated
SC23555	BiPower
SC24555	Longlife+
SC25555	Longlife+
SC26555	Longlife+

#### Electroplated Kit ●

CODE	TECHNOLOGY
SC27655	Electroplated
SC28655	Electroplated
SC23655	BiPower
SC24655	Longlife+
SC25655	Longlife+
SC26655	Longlife+

#### Electroplated Kit ●

POS.	CODE	TECHNOLOGY
1	SC27255	Electroplated
2	SC28255	Electroplated
3	SC23255	BiPower
4	SC24255	Longlife+
5	SC25255	Longlife+
6	SC26255	Longlife+

#### Electroplated Kit ●

CODE	TECHNOLOGY
SC27260	Electroplated
SC28260	Electroplated
SC23260	BiPower
SC24260	Longlife+
SC25260	Longlife+
SC26260	Longlife+

#### Electroplated Kit ●

CODE	TECHNOLOGY
SC27755	Electroplated
SC28755	Electroplated
SC23755	BiPower
SC24755	Longlife+
SC25755	Longlife+
SC26755	Longlife+



Introducing our Recess & Stubbing Wheels collection – a precision-engineered lineup designed to redefine material shaping and profiling. From heavy-duty Super Duty wheels to versatile Segmented options and specialized Electroplated wheels for marble and travertine, we empower countertop professionals with the right tools for every task. With sizes ranging from 50mm to 90mm, our wheels ensure accuracy and efficiency in material removal. Plus, we provide a complete solution – adapters of all sizes are readily available, enabling seamless integration into your existing equipment. Elevate your fabrication process with Marmoelettromeccanica's exceptional tools and comprehensive support.

# Stubbing Wheels



**Super Duty Wheels**

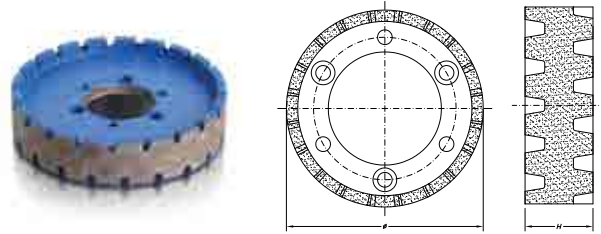

CODE	DESCRIPTION	FITTING
SC03106	H30 - Ø85	3 Hole Ø50 Flange
SC03107	H30 - Ø90	3 Hole Ø50 Flange
SC03111	H30 - Ø50	3 Hole Ø14 Flange

\* Adapters: SA01037 & SA01038

**Sintered Wheels**

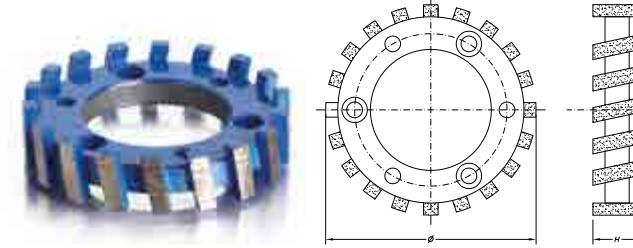

CODE	DESCRIPTION	FITTING
SC03007	H20 - Ø87 - SINTERED	3 Hole Ø50 Flange
SC03008	H20 - Ø87 - SINTERED	3 Hole Ø50 Flange
SC03066	H20 - Ø90 - SINTERED	3 Hole Ø50 Flange
SC03010	H30 - Ø90 - SINTERED	3 Hole Ø50 Flange

\* Adapter: SA01038

**Small Sintered Wheels**

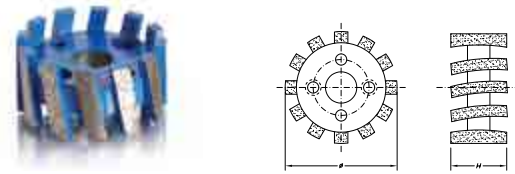

CODE	DESCRIPTION	FITTING
SC03001	H25 - Ø50	3 Hole Ø14 Flange

\* Adapter: SA01037

**Electroplated Wheels**

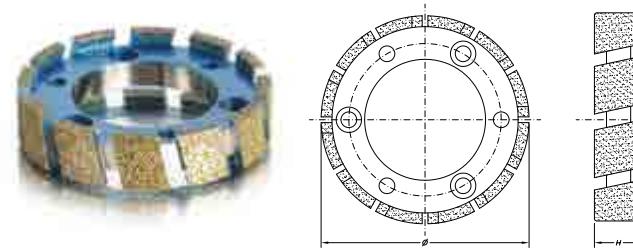

CODE	DESCRIPTION	FITTING
SC03015	H20 - Ø87	3 Hole Ø50 Flange

\* Adapter: SA01038

**Small Electroplated Wheels**

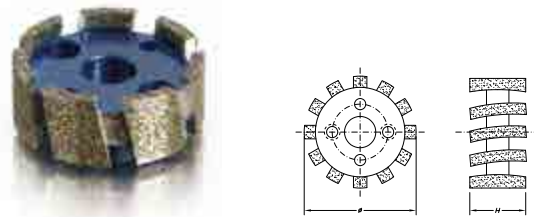

CODE	DESCRIPTION	FITTING
SC03050	H20 - Ø50	3 Hole Ø14 Flange

\* Adapter: SA01037

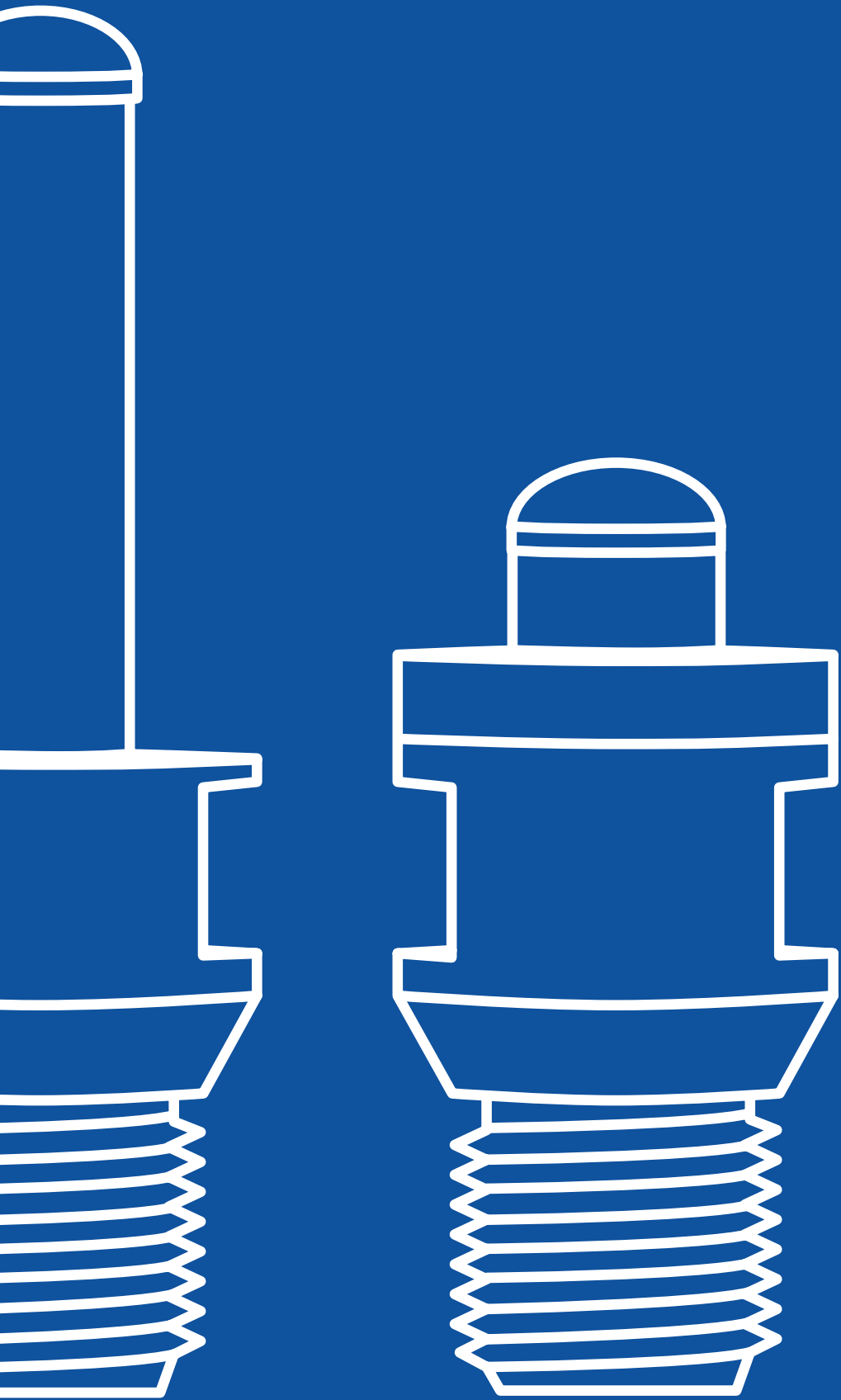

# Drainboard & Grooving Tools

Elevate your countertop craftsmanship with our cutting-edge "Drainboard and Grooving Tools." This meticulously curated collection empowers you to fashion impeccable pitched drainboards, runnels, and intricate grooves. Choose from versatile angle options of 45 or 60 degrees for flawless drainboard edges. Our honed finish bits and polishing discs effortlessly refine grooves in just three swift steps. Crafted with precision, these tools redefine efficiency and perfection in drainage and grooving tasks. From standard designs to customizable solutions, Marmoelettromeccanica is your trusted partner, enabling innovation and precision in every project. Embrace limitless possibilities and reimagine countertop elegance with our unparalleled toolset.



**45° Pitched Drainboard Set**

POS.	CODE	DESCRIPTION	FITTING
1	SC03024	45° SEGMENTED - GRIT 50/60 - Ø100	½" Gas
2	SC03025	45° SEGMENTED - GRIT 240/270 - Ø100	½" Gas
3	SC03046	45° POLISHER - GRIT 600 - Ø100	SA01038
4	SC03048	45° POLISHER - GRIT 1500 - Ø100	SA01038
5	SC03054	FLAT POLISHER - GRIT 100 - Ø100	SA01061
6	SC03055	FLAT POLISHER - GRIT 200 - Ø100	SA01061
7	SC03056	FLAT POLISHER - GRIT 500 - Ø100	SA01061
8	SC03058	FLAT POLISHER - GRIT 1000 - Ø100	SA01061
9	SC03059	FLAT POLISHER - GRIT 2000 - Ø100	SA01061
10	SC03060	FLAT POLISHER - GRIT 3000 - Ø100	SA01061

SC03008 Stubbing is used as position 0

**60° Pitched Drainboard Set**

POS.	CODE	DESCRIPTION	FITTING
1	SC03031	60° SEGMENTED - GRIT 50/60 - Ø100	½" Gas
2	SC03032	60° SEGMENTED - GRIT 240/270 - Ø100	½" Gas
3	SC03051	60° POLISHER - GRIT 600 - Ø100	SA01038
4	SC03053	60° POLISHER - GRIT 1500 - Ø100	SA01038
5	SC03054	FLAT POLISHER - GRIT 100 - Ø100	SA01061
6	SC03055	FLAT POLISHER - GRIT 200 - Ø100	SA01061
7	SC03056	FLAT POLISHER - GRIT 500 - Ø100	SA01061
8	SC03058	FLAT POLISHER - GRIT 1000 - Ø100	SA01061
9	SC03059	FLAT POLISHER - GRIT 2000 - Ø100	SA01061
10	SC03060	FLAT POLISHER - GRIT 3000 - Ø100	SA01061

SC03008 Stubbing is used as position 0



**Grooving bits**

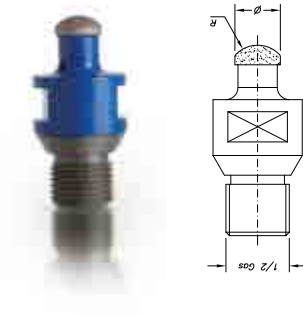
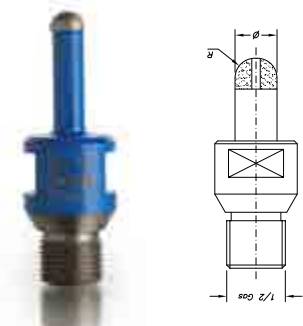

POS.	CODE	DESCRIPTION	FITTING
1	SC04061	Ø10 r5 - SINTERED	½" Gas
2	SC04062	Ø10 r5 - SINTERED	½" Gas
3	SC04063	Ø10 r5 - SINTERED	½" Gas
1	SC04001	Ø12 r6 - SINTERED	½" Gas
2	SC04002	Ø12 r6 - SINTERED	½" Gas
3	SC04003	Ø12 r6 - SINTERED	½" Gas
1	SC04074	Ø16 r8 - SINTERED	½" Gas
2	SC04075	Ø16 r8 - SINTERED	½" Gas
3	SC04076	Ø16 r8 - SINTERED	½" Gas
1	SC04026	Ø20 r10 - SINTERED	½" Gas
2	SC04027	Ø20 r10 - SINTERED	½" Gas
3	SC04028	Ø20 r10 - SINTERED	½" Gas
1	SC04081	Ø24 r12 - SINTERED	½" Gas
2	SC04082	Ø24 r12 - SINTERED	½" Gas
3	SC04083	Ø24 r12 - SINTERED	½" Gas
1	SC04014	Ø15 r10 - SINTERED	½" Gas
2	SC04015	Ø15 r10 - SINTERED	½" Gas
3	SC04016	Ø15 r10 - SINTERED	½" Gas

**Grooving disc for Runnels**

POS.	CODE	DESCRIPTION	FITTING
1	SC04105	Ø128 h10 r5 - ZENITH	Bore 50
2	SC04107	Ø128 h10 r5 - LONGLIFE	Bore 50
3	SC04109	Ø128 h10 r5 - LONGLIFE	Bore 50
1	SC04171	Ø128 h12 r6 - ZENITH	Bore 50
2	SC04172	Ø128 h12 r6 - LONGLIFE	Bore 50
3	SC04173	Ø128 h12 r6 - LONGLIFE	Bore 50
1	SC04174	Ø128 h16 r8 - ZENITH	Bore 50
2	SC04175	Ø128 h16 r8 - LONGLIFE	Bore 50
3	SC04176	Ø128 h16 r8 - LONGLIFE	Bore 50
1	SC04177	Ø128 h20 r10 - ZENITH	Bore 50
2	SC04178	Ø128 h20 r10 - LONGLIFE	Bore 50
3	SC04179	Ø128 h20 r10 - LONGLIFE	Bore 50
1	SC04181	Ø128 h24 r12 - ZENITH	Bore 50
2	SC04182	Ø128 h24 r12 - LONGLIFE	Bore 50
3	SC04183	Ø128 h24 r12 - LONGLIFE	Bore 50





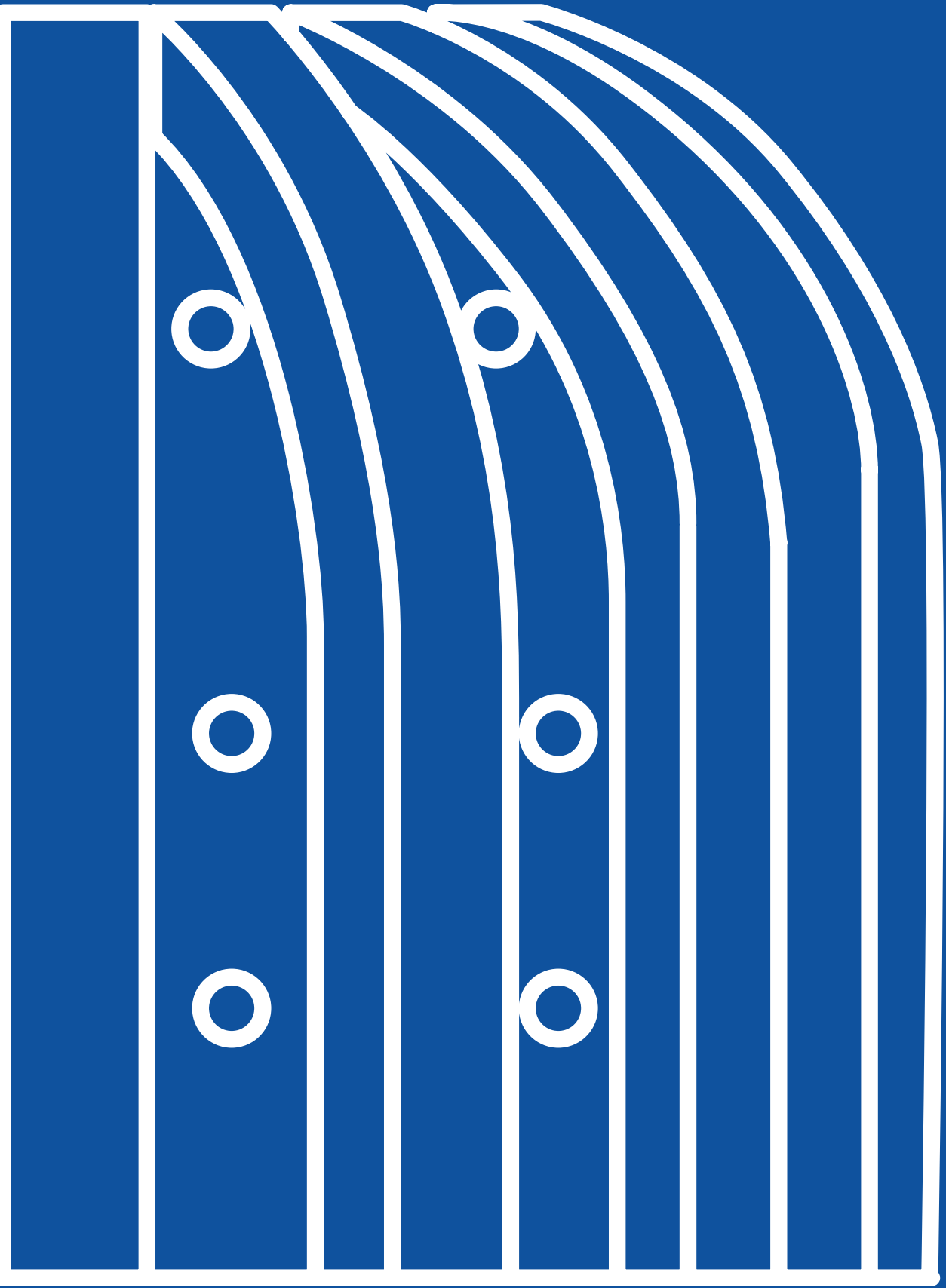

Experience the pinnacle of stone craftsmanship with Marmoelettromeccanica's Solid Sink Tools. Our comprehensive collection offers universal sets featuring segmented technology, along with electroplated sets tailored for marble and travertine. Choose between a glossy or antique/leathered finish to achieve the perfect aesthetic. Craft flawless and functional sink, tub, and shower bases from solid stone blocks. Elevate your designs with precision and artistry that redefine stone fabrication. Marmoelettromeccanica empowers your vision for impeccable and personalized stone fixtures.

# Solid Sink Tools



Electroplated



POS.	CODE	DESCRIPTION	FITTING
1	SC05003	#30/40 - Ø85 - H60 - R25mm	Bore 35
2	SC05004	#100/120 - Ø85 - H60 - R25mm	Bore 35

\* Adapter: SA01034

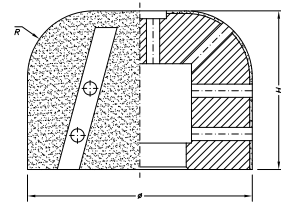

Polishing tools



POS.	CODE	DESCRIPTION	FITTING
3	SC03040	BIPOWER - Ø85 - H60 - R25mm	Bore 35
4	SC03041	LOGLIFE - Ø85 - H60 - R25mm	Bore 35
5	SC03042	LOGLIFE - Ø85 - H60 - R25mm	Bore 35
6	SC03043	LOGLIFE - Ø85 - H60 - R25mm	Bore 35

\* Adapter: SA01034



Sintered



POS.	CODE	DESCRIPTION	FITTING
1	SC05005	Ø85 - H60 - R25mm	Bore 35
2	SC05006	Ø85 - H60 - R25mm	Bore 35

\* Adapter: SA01034

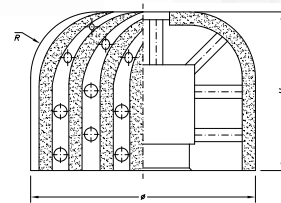

Aging tools



POS.	CODE	DESCRIPTION	FITTING
4	ST03074	#46 - Ø85 - H60 - R25mm	Bore 35
5	ST03075	#80 - Ø85 - H60 - R25mm	Bore 35
6	ST03076	#120 - Ø85 - H60 - R25mm	Bore 35

\* Adapter: SA01034



Unveil the artistry within stone with Marmoelettromeccanica's Engraving Tools. A fusion of innovation and precision, our tools redefine stone embellishment. Choose from two dynamic categories: the Double Cutting Edge, seamlessly integrating a ½" fitting, and the Single Cutting Edge, boasting a 10mm diameter shaft for intricate detailing. Craft masterpieces from every angle and inclination, from shallow etchings to profound designs. Elevate your stone engraving with advanced Widia and Tungsten Carbide technologies, ensuring longevity and intricacy. With Marmoelettromeccanica, your creativity takes center stage, shaping timeless elegance in stone. If you seek further insights or customization, we're dedicated to your vision.

# Engraving Tools

Double Widia



CODE	DESCRIPTION	FITTING
SW01005	3x30	½" Gas
SW01006	5x30	½" Gas
SW01007	8x30	½" Gas

Single Widia



CODE	DESCRIPTION	FITTING
SW01001	30°	Collet
SW01009	30° SURFACE 1	Collet
SW01010	30° SURFACE 3	Collet
SW01002	60°	Collet
SW01003	90°	Collet
SW01004	FLAT	Collet

ø 10mm





# Cones & Adapters

Introducing our versatile adapters, designed to seamlessly integrate with a wide array of custom-designed items. We take pride in our commitment to adaptability, offering a solution that effortlessly accommodates your unique specifications. Our adapters provide the essential link between your distinct creations and various systems, ensuring flawless functionality and optimal performance. With a focus on precision and innovation, our adapters are engineered to empower your creative freedom. Experience the convenience of tailor-made solutions that effortlessly connect your designs to the world, setting new standards in adaptability and versatility.



**TOOL HOLDER**  
Equipped with locking set and shank



**FLANGE**  
Equipped with shank



**1/2 GAS HOLDER**  
Equipped with shank



**COLLET HOLDER**  
Equipped with shank. Collet Excluded

**ISO 40 BREMBANA - Old Type**

CODE	DESCRIPTION	FITTING	Ø (mm)	L (mm)
SA01003	Tool holder	-	35	47
SA01231	Flange	Flange	50	5
SA01014	1/2" Gas holder	1/2" Gas	45	45
SA01241	1/2" Gas holder	M30	45	45
SA01252	Collet holder	ER32	50	42,5
SA01253	Collet holder	ER40	63	46,5

**ISO 40 BREMBANA - New Type**

CODE	DESCRIPTION	FITTING	Ø (mm)	L (mm)
SA01002	Tool holder	-	35	47
SA01177	Flange	Flange	50	5
SA01013	1/2" Gas holder	1/2" Gas	50	50
SA01240	1/2" Gas holder	M30	50	50
SA01186	Collet holder	ER32	50	53,4
SA01251	Collet holder	ER40	63	57,15

**ISO 40 RAVELLI**

CODE	DESCRIPTION	FITTING	Ø (mm)	L (mm)
SA01008	Tool holder	-	30	148
SA01009	Tool holder	-	45	148
SA01019	1/2" Gas holder	1/2" Gas	54	51,6
SA01245	1/2" Gas holder	M30	54	51,6
SA01262	Collet holder	ER32	50	60
SA01263	Collet holder	ER40	63	70

**ISO 40 INTERMAC**

CODE	DESCRIPTION	FITTING	Ø (mm)	L (mm)
SA01006	Tool holder	-	35	47
SA01042	Flange	Flange	50	5
SA01017	1/2" Gas holder	1/2" Gas	75	0
SA01243	1/2" Gas holder	M30	75	0
SA01258	Collet holder	ER32	50	52,5
SA01259	Collet holder	ER40	63	56,5

**ISO 40 BIMATECH**

CODE	DESCRIPTION	FITTING	Ø (mm)	L (mm)
SA01007	Tool holder	-	35	47
SA01233	Flange	Flange	50	5
SA01018	1/2" Gas holder	1/2" Gas	75	0
SA01244	1/2" Gas holder	M30	75	0
SA01260	Collet holder	ER32	50	52,5
SA01261	Collet holder	ER40	63	56,5

**ISO 40 NORTHWOOD**

CODE	DESCRIPTION	FITTING	Ø (mm)	L (mm)
SA01182	Tool holder	-	35	47
SA01236	Flange	Flange	50	5
SA01183	1/2" Gas holder	1/2" Gas	75	0
SA01248	1/2" Gas holder	M30	75	0
SA01268	Collet holder	ER32	50	52,5
SA01269	Collet holder	ER40	63	56,5

**HSK 80B BRETON**

CODE	DESCRIPTION	FITTING	Ø (mm)	L (mm)
SA01005	Tool holder	-	35	47
SA01232	Flange	Flange	50	5
SA01016	1/2" Gas holder	1/2" Gas	67	44
SA01218	1/2" Gas holder	M30	67	44
SA01256	Collet holder	ER32	50	94
SA01257	Collet holder	ER40	63	94

**ISO 40 DENVER - VEM - THIBAUT - HELIOS - PARK INDUSTRIES**

CODE	DESCRIPTION	FITTING	Ø (mm)	L (mm)
SA01011	Tool holder	-	35	47
SA01044	Flange	Flange	50	5
SA01021	1/2" Gas holder	1/2" Gas	45	23
SA01180	1/2" Gas holder	M30	45	23
SA01266	Collet holder	ER32	50	72,5
SA01267	Collet holder	ER40	63	76,25

**ISO 40 PEDRINI - COLBAM**

CODE	DESCRIPTION	FITTING	Ø (mm)	L (mm)
SA01213	Tool holder	-	35	47
SA01355	Flange	Flange	50	5
SA01319	1/2" Gas holder	1/2" Gas	50	50
SA01385	1/2" Gas holder	M30	50	50
SA01331	Collet holder	ER32	50	72,5
SA01386	Collet holder	ER40	63	72,5

**ISO 40 OMAG**

CODE	DESCRIPTION	FITTING	Ø (mm)	L (mm)
SA01010	Tool holder	-	35	47
SA01170	Tool holder	-	50	5
SA01020	1/2" Gas holder	1/2" Gas	50	50
SA01246	1/2" Gas holder	M30	50	50
SA01388	Collet holder	ER32	50	72,5
SA01389	Collet holder	ER40	63	72,5

**ISO 40 BAVELLONI - SCANDINVENT**

CODE	DESCRIPTION	FITTING	Ø (mm)	L (mm)
SA01001	Tool holder	-	25	47
SA01337	Tool holder	-	35	47
SA01387	Flange	Flange	50	70
SA01012	1/2" Gas holder	1/2" Gas	50	50
SA01239	1/2" Gas holder	M30	50	50
SA01249	Collet holder	ER32	50	72,5
SA01250	Collet holder	ER40	63	72,5

**ISO 50 OMAG**

CODE	DESCRIPTION	FITTING	Ø (mm)	L (mm)
SA01237	Tool holder	-	35	47
SA01235	Flange	Flange	50	5
SA01238	1/2" Gas holder	1/2" Gas	50	50
SA01247	1/2" Gas holder	M30	50	50
SA01264	Collet holder	ER32	50	72,5
SA01265	Collet holder	ER40	63	72,5

**1/2" Gas Fitting Tool holder**

For wheels with bore Ø22 mm

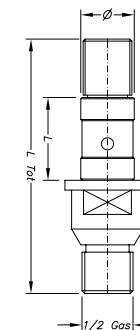

CODE	FITTING	Ø (mm)	L (mm)	L TOT (mm)
SA01022	For wheel heights from 28 to 35 mm	22	33	100
SA01040	For wheel heights from 42 to 49 mm	22	47	113
SA01041	For wheel heights from 55 to 62 mm	22	60	125

The adaptor is equipped with 2 spacers and tool locking nut.

**1/2" Gas Fitting Tool holder**

Steel. For wheels with bore Ø35 mm

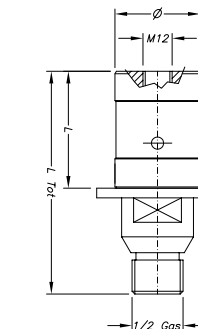

CODE	Ø (mm)	L (mm)	L TOT (mm)
SA01055	35	48	92,0

The adaptor is equipped with washers and tool locking screw.

**M30 Fitting**

For lathe tools

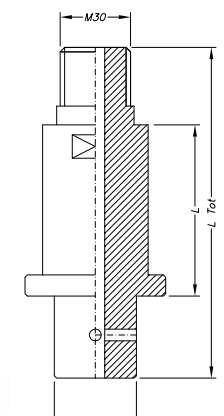

CODE	Ø (mm)	L (mm)	L TOT (mm)
SA01034	35	140	205

Wheel shaft: 34mm.  
The adaptor is equipped with washers and tool locking screw.





**Flange Fitting**

Steel. For wheels with bore Ø35 mm

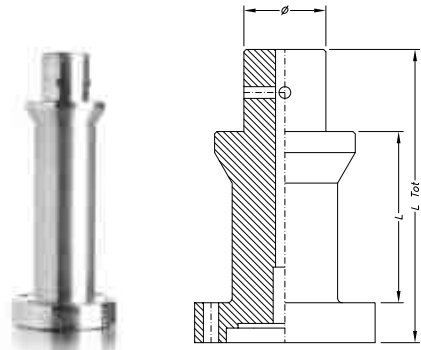

CODE	Ø (mm)	L (mm)	L TOT (mm)
SA01035	35,0	70	121
SA01036	35,0	140	191
SA01214	35,0	200	251

Top end: Flange fitting.  
Wheel shaft: 34mm.

The adaptor is equipped with washers and tool locking screw.

**1/2" Gas Fitting**

For drainboard wheels Ø87-91 mm with bore Ø50 mm

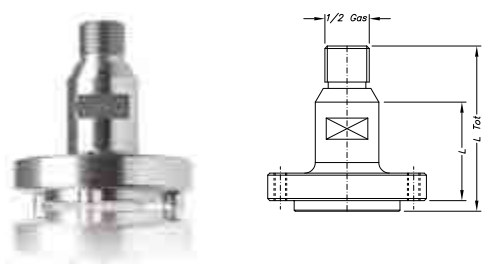

CODE	L (mm)	L TOT (mm)
SA01038	47	75

The adaptor comes with washer and locking screw-

**1/2" Gas Adaptor Fitting Ø 10 mm**

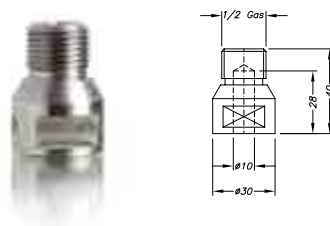

CODE	L (mm)	L TOT (mm)
SA01326	28	40

**1/2" Gas Fitting**

For drainboard wheels Ø50 mm with bore Ø14 mm

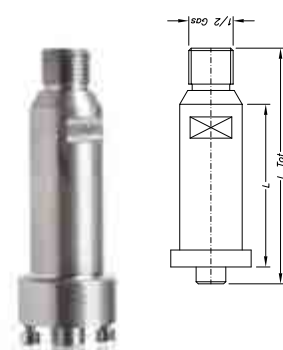

CODE	L (mm)	L TOT (mm)
SA01037	45	77
SA01159	86	118
SA01160	136	168
SA01161	186	218
SA01162	236	268

The adaptor is equipped with washers and tool locking screw.

**Magnetic Fitting for Drainboard Wheel**

For flat polishing drainboard wheels with magnetic fitting

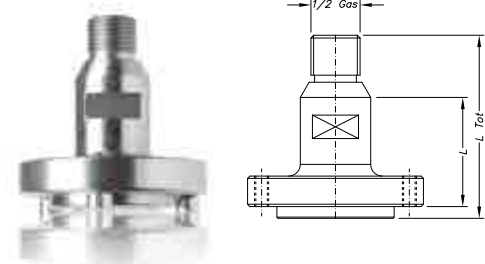

CODE	L (mm)	L TOT (mm)
SA01061	39	65

**BUSHING FOR LINE 60 - EHS - EHS PLUS 5 mm**

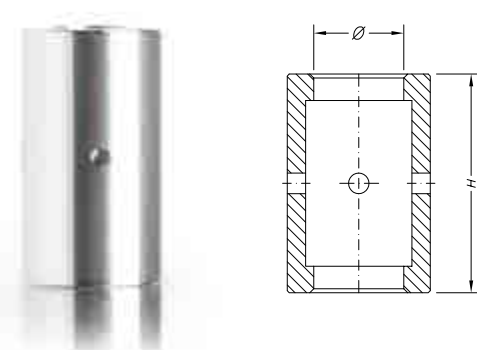

PROFILE	H	CODE Ø20	CODE Ø22	CODE Ø25	CODE Ø30
A20 r10	41,5	SA01082	SA01083	SA01084	SA01085
A30 r3	53,5	SA01110	SA01111	SA01112	SA01113
A30 Rr5	53,5	SA01110	SA01111	SA01112	SA01113
A30 r6	53,5	SA01110	SA01111	SA01112	SA01113
A30 r8	53,5	SA01110	SA01111	SA01112	SA01113
A30 r10	53,5	SA01110	SA01111	SA01112	SA01113
A30 r15	53,5	SA01110	SA01111	SA01112	SA01113
A30 r20	53,5	SA01110	SA01111	SA01112	SA01113
A40 r20	61,5	SA01130	SA01131	SA01132	SA01133
B20	37,5	SA1074	SA01075	SA01076	SA01077
B30 r25	53,5	SA01110	SA01111	SA01112	SA01113
B30	53,5	SA01110	SA01111	SA01112	SA01113
E20	41,5	SA01082	SA01083	SA01084	SA01085
E30	53,5	SA01110	SA01111	SA01112	SA01113
E40	53,5	SA01110	SA01111	SA01112	SA01113
F20	37,5	SA01074	SA01075	SA01076	SA01077
F30	45,5	SA01086	SA01087	SA01088	SA01089
F+V40	57,5	SA01118	SA01119	SA01120	SA01121
FZ30 r10	45,5	SA01086	SA01087	SA01088	SA01089
FZ40 r10	45,5	SA01086	SA01087	SA01088	SA01089
G30	49,5	SA01102	SA01103	SA01104	SA01105
H20	33,5	SA01066	SA01067	SA01068	SA01069
H30	41,5	SA01082	SA01083	SA01084	SA01085
M30	53,5	SA01110	SA01111	SA01112	SA01113
O20	37,5	SA01074	SA01075	SA01076	SA01077
O30	41,5	SA01082	SA01083	SA01084	SA01085
OG20	45,5	SA01086	SA01087	SA01088	SA01089
OG30	53,5	SA01110	SA01111	SA01112	SA01113
Pre-cut O	45,5	SA01086	SA01087	SA01088	SA01089
Pre-cut C	57,5	SA01086	SA01119	SA01120	SA01121
Q20	33,5	SA01118	SA01067	SA01068	SA01069
Q30	45,5	SA01066	SA01087	SA01088	SA01089
T20 r2,5	45,5	SA01086	SA01087	SA01088	SA01089

PROFILE	H	CODE Ø20	CODE Ø22	CODE Ø25	CODE Ø30
T20 r3	45,5	SA01086	SA01087	SA01088	SA01089
T20 r5	41,5	SA01082	SA01083	SA01084	SA01085
T30 r3	57,5	SA01118	SA01119	SA01120	SA01121
T30 r5	65,5	SA01142	SA01143	SA01144	SA01145
T30 r8	57,5	SA01118	SA01119	SA01120	SA01121
T30 r10	65,5	SA01142	SA01143	SA01144	SA01145
T40 r3	65,5	SA01142	SA01143	SA01144	SA01145
T40 r3,5	65,5	SA01142	SA01143	SA01144	SA01145
T40 r5	65,5	SA01142	SA01143	SA01144	SA01145
TP20	37,5	SA01074	SA01075	SA01076	SA01077
TP30	49,5	SA01102	SA01103	SA01104	SA01105
V20	41,5	SA01082	SA01083	SA01084	SA01085
V30	49,5	SA01102	SA01103	SA01104	SA01105
V31,7	61,5	SA01130	SA01131	SA01132	SA01133
V40	61,5	SA01130	SA01131	SA01132	SA01133
V50	81,5	SA01316	SA01215	SA01317	SA01318
V60	91,5	SA01150	SA01151	SA01152	SA01153
V+Q30	49,5	SA01102	SA01103	SA01104	SA01105
X+D20	45,5	SA01086	SA01087	SA01088	SA01089
X+D30	65,5	SA01142	SA01143	SA01144	SA01145
Ys20 1,5x1,5	41,5	SA01082	SA01083	SA01084	SA01085
YS20 3x3	41,5	SA01082	SA01083	SA01084	SA01085
YS30 2x2	41,5	SA01082	SA01083	SA01084	SA01085
YS30 3x3	49,5	SA01102	SA01103	SA01104	SA01105
YS40 3x3	61,5	SA01130	SA01131	SA01132	SA01133
Z30	33,5	SA01066	SA01067	SA01068	SA01069
Z30 Ø80	37,5	SA01074	SA01075	SA01076	SA01077
Z40 Ø80	49,5	SA01102	SA01103	SA01104	SA01105
Z40	45,5	SA01086	SA01087	SA01088	SA01089
Z50	53,5	SA01110	SA01111	SA01112	SA01113
Z60	65,5	SA01142	SA01143	SA01144	SA01145
ZS30	45,5	SA01086	SA01087	SA01088	SA01089
ZS40	57,5	SA01118	SA01119	SA01120	SA01121

**BUSHINGS**



CODE
SA01154



**Marmoelettromeccanica**

Via Flaminia km 41,400  
Rignano Flaminio, RM 00068 | Italy  
T +39 0761 5051

2400 Main Street  
Sayreville, NJ 08872 | US  
T +1 833 MEM TOOL

[marmoelettro.com](http://marmoelettro.com)

